



Battery Monitoring Device



OWNER'S MANUAL

Model Numbers: 300Q,
300B8, 310Q, 310S, and 301Q



UL Listing applies to certain models only.

www.enersys.com



CONTENTS

Introduction	3
Features	4
Technical Specifications	4
Dimensions	5
Installation	6
300Q.....	6
300B8.....	10
310Q.....	14
310S.....	19
301Q.....	24
Visual LED Indication	28
Connectivity	29
Frequently Asked Questions (FAQs).....	32
Spare Parts	33



Model no. 300Q



Model no. 300B8



Model no. 310Q



Model no. 310S



Model no. 301Q

INTRODUCTION



The information contained in this document is critical for safe handling and proper use of the iQ Mini™ battery monitoring device. It contains a global system specification as well as related safety measures, codes of behavior, a guideline for commissioning and recommended maintenance. This document must be retained and available for users working with and responsible for the battery monitoring device. All users are responsible for ensuring that all applications of the system are appropriate and safe, based on conditions anticipated or encountered during operation.

This owner's manual contains important safety instructions. Read and understand the sections on safety and operation of the battery monitoring device before operating the battery monitoring device and the equipment into which it is installed.

It is the owner's responsibility to ensure the use of the documentation and any activities related thereto, and to follow all legal requirements applicable to themselves and the applications in the respective countries.

This owner's manual is not intended to substitute for any training on handling and operating the iQ Mini™ battery monitoring device that may be required by local laws and/or industry standards. Proper instruction and training of all users must be ensured prior to any contact with the battery system.

For service, contact your sales representative or call:

EnerSys EMEA
EH Europe GmbH
Baarerstrasse 18
6300 Zug, Switzerland
Tel: +41 44 215 74 10

EnerSys World Headquarters
2366 Bernville Road
Reading, PA 19605, USA
Tel: +1-610-208-1991
+1-800-538-3627

EnerSys APAC
No. 85, Tuas Avenue 1
Singapore 639518
+65 6558 7333

www.enersys.com

Your Safety and the Safety of others is Very Important

⚠ WARNING You can be killed or seriously injured if you don't follow instructions.

FEATURES & SPECIFICATIONS

Features

- Real time status
- Low voltage alert
- iQ Mini™ battery monitoring device can be installed on multiple battery types
- Single polarity input, reverse protected
- External voltage tap—measuring total battery voltage and number of cells
- Super bright LED indicators
- iQ Mini™ battery monitoring device mode status indicators
- Multiple connection types
- Small and slim fit
- Simple to use
- Easy to install
- Automatic data upload

Technical Specifications

	300Q	300B8	310Q	310S	301Q
Battery Technology	TPPL Battery		Flooded Battery		TPPL Battery
Connection Types	FlexiTap (Q)	Bolt (B8)	FlexiTap (Q)	M4 Screw (S)	FlexiTap (Q)
Nominal Battery Voltage	12V, 24V, 36V, 48V, 80V *Voltage is locked in after 30 mins.		12V, 24V, 36V, 48V, 80V *Voltage is locked in after 30 mins.		12V, 24V, 36V, 48V, 80V *Voltage is locked in after 30 mins.
Operating Voltage	4.5V – 38V MAX		4.5V – 38V MAX		4.5V – 38V MAX
Voltage Measurement	4.5V – 120V		4.5V – 120V		4.5V – 120V
Operating Current	1.6mA – 10mA		1.6mA – 10mA		1.6mA – 10mA
Operating Temperature	-20°C to +60°C (-4°F to +140°F)		-20°C to +60°C (-4°F to +140°F)		-20°C to +60°C (-4°F to +140°F)
Temperature Monitoring	Internal sensor		Internal sensor		External sensor
Wireless Range	Up to 100m/328ft (Unobstructed)		Up to 100m/328ft (Unobstructed)		Up to 100m/328ft (Unobstructed)
Data Storage	Cumulative data and last 9 cycle data packets		Cumulative data and last 9 cycle data packets		Cumulative data and last 9 cycle data packets
Data Collection	Via gateway/app		Via gateway/app		Via gateway/app
Power Consumption	Nominal current		Nominal current		Nominal current
Protection	Overvoltage and reverse polarity protection		Overvoltage and reverse polarity protection		Overvoltage and reverse polarity protection
Physical Dimensions	80 mm (L) x 29 mm (W) x 20 mm (H)/ 3.14 in (L) x 1.14 in (W) x 0.79 in (H)		80 mm (L) x 29 mm (W) x 20 mm (H)/ 3.14 in (L) x 1.14 in (W) x 0.79 in (H)		80 mm (L) x 29 mm (W) x 20 mm (H)/ 3.14 in (L) x 1.14 in (W) x 0.79 in (H)

	300Q	300B8	310Q	310S	301Q
Compliance	<p>2014/53/EU - Radio Equipment Safety: EN 62368-1:2014+A11:2017 EMC: EN IEC 61326-1:2021 Radio Frequency: EN IEC 62311:2020 / EN 50385:2017/EN 50665:2017 EN 300 328 V2.1.1 (2016-11) EN 300 328 V2.2.2 EN 301 489-17 - V3.2.0</p> <p>2011/65/EU - Restriction of the use of certain hazardous substances RoHS: EN 62321-8:2017 EN 62321-3-1:2013 EN 62321-4:2013/AMD1:2017 EN 62321-5:2013 EN 62321-6:2015 EN 62321-7-1:2015, EN 62321-7-2:2017</p>				

DIMENSIONS

Dimensions

iQ mini™ Battery Monitoring Device Overall Dimensions
Figure 1: iQ Mini™ Battery Monitoring Device Dimensions

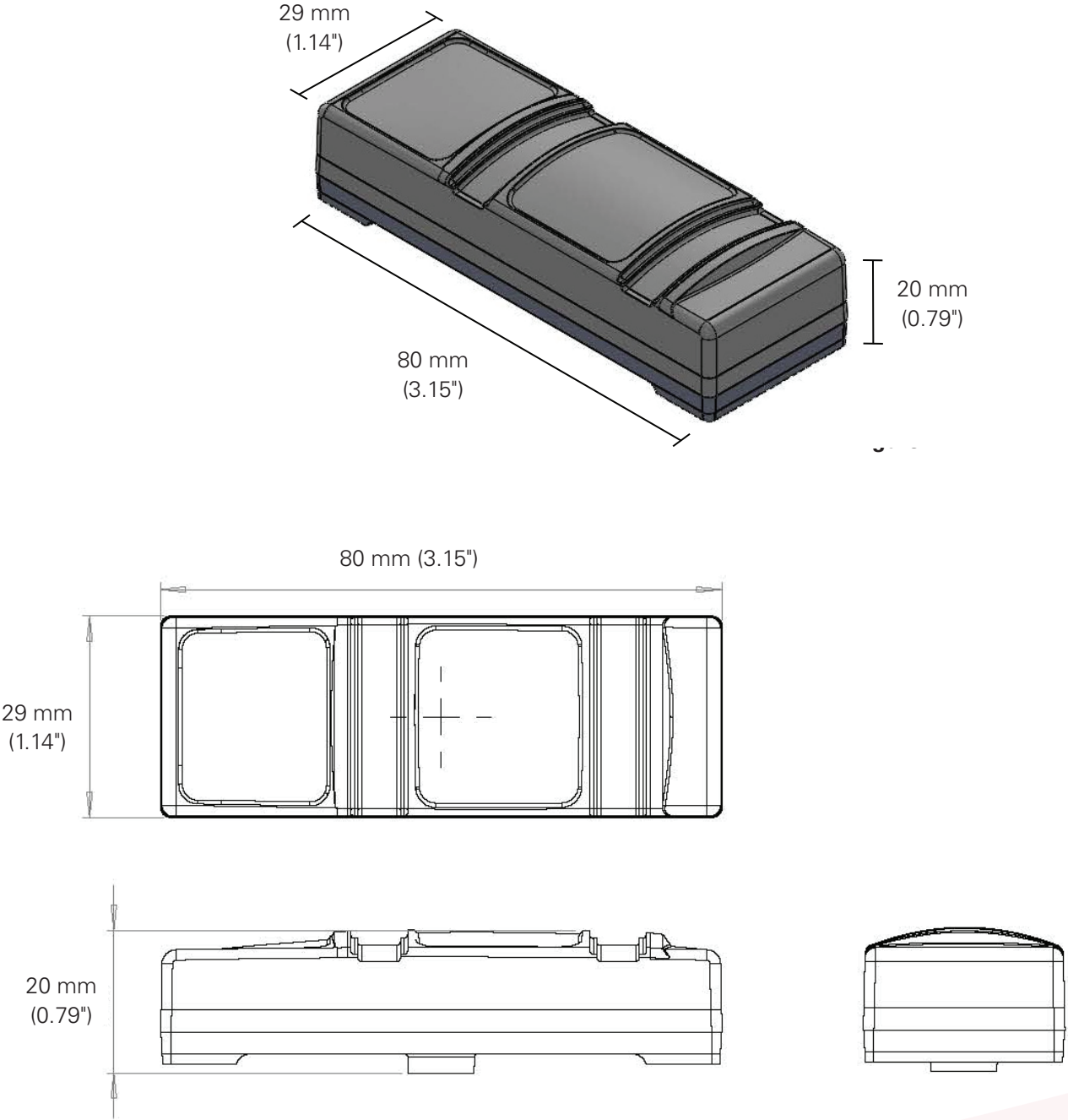

*All dimensions are given in mm (inch).

INSTALLATION

Installation: Model No. 300Q

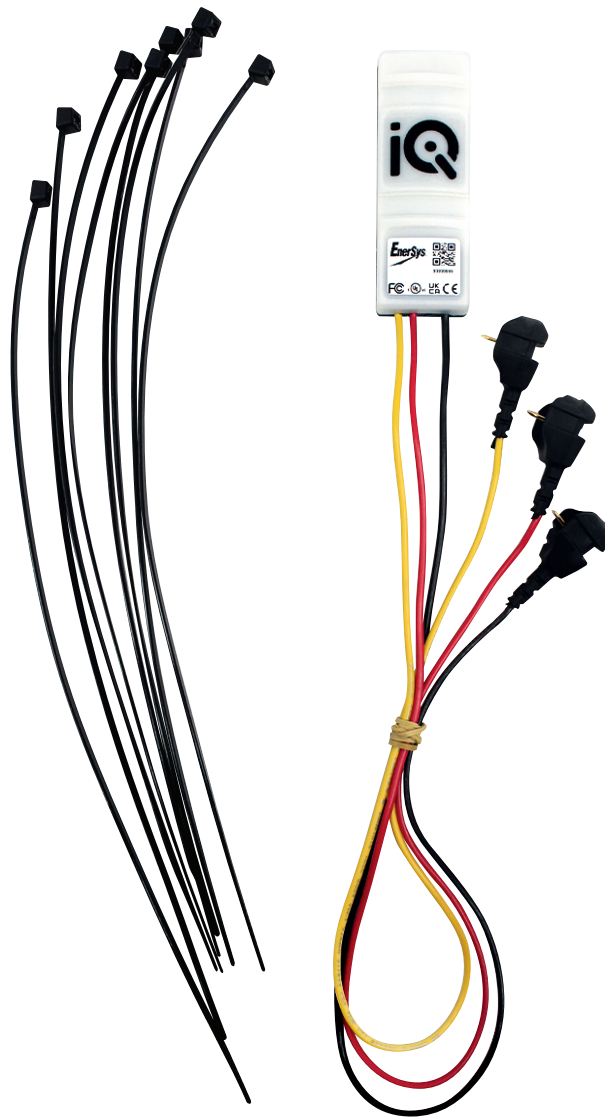

The iQ Mini™ battery monitoring device - 300Q is a battery life monitor that provides real-time status and is intended for use on 12V to 80V TPPL batteries.

The iQ Mini™ battery monitoring device monitors and records cycles, temperatures, and automatically sends this data to a gateway or app for visualisation online.

It provides LED indications for overtemperature and communication. If the status of the battery is OK and the device is working OK, it will flash green every 10 seconds.

INSTALLATION

Installation: Model No. 300Q (cont.)

Tools required



Sample cells layout

Figure 2: iQ Mini™ Battery Monitoring Device Final Assembly on 24VTPPL Batteries

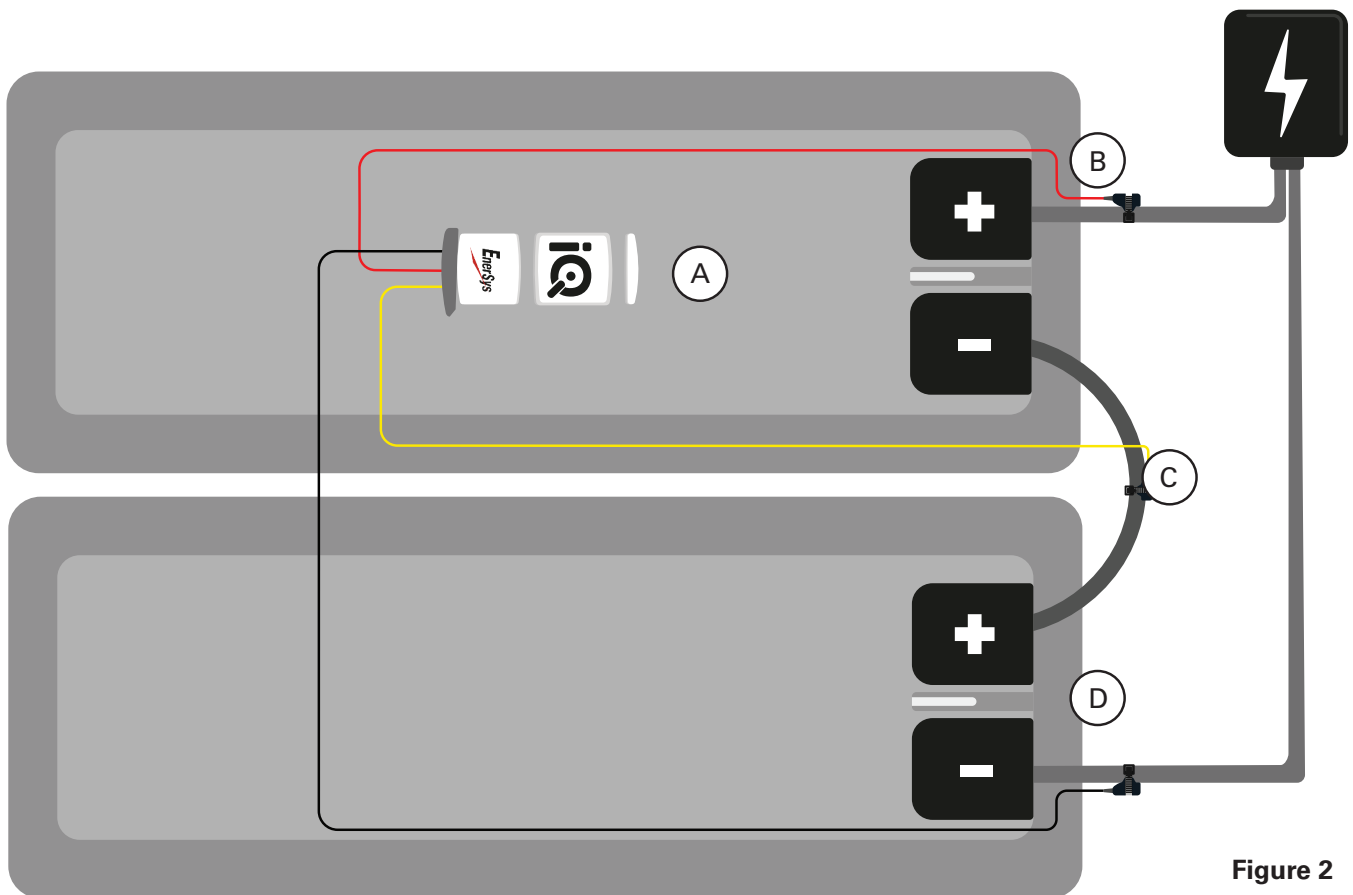

Figure 2



(A) iQ Mini™ Battery Monitoring Device - 300Q

(B) (C) (D) Connection - Q

INSTALLATION

Installation: Model No. 300Q (cont.)

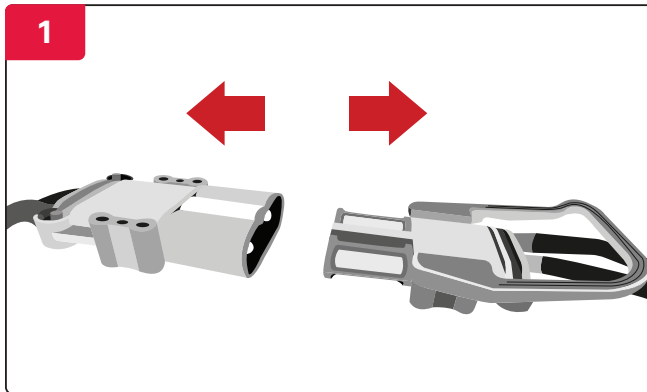

Ensure the voltage is between 2.0 and 2.25 volts per cell before installation.

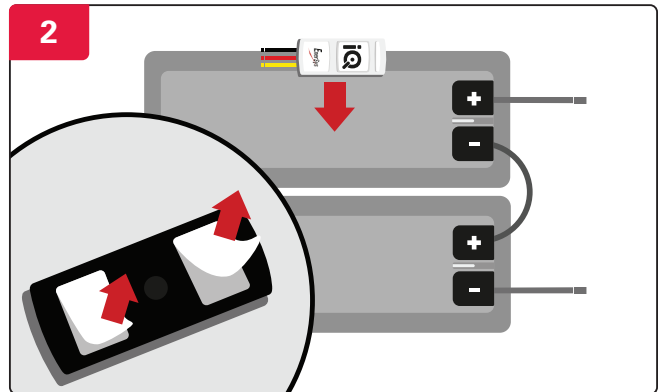

Attach the iQ Mini™ Battery Monitoring Device to the top of the battery.

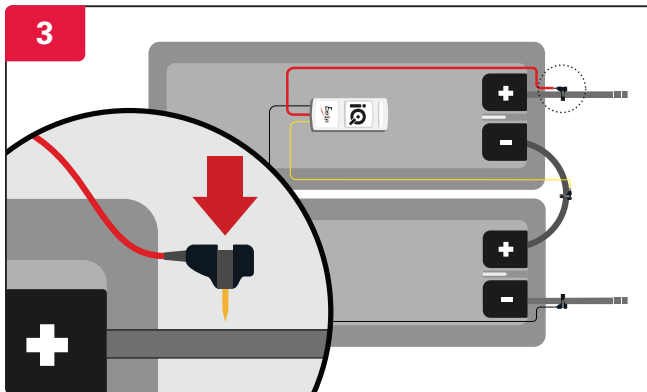

Connect the red cable to the positive terminal.

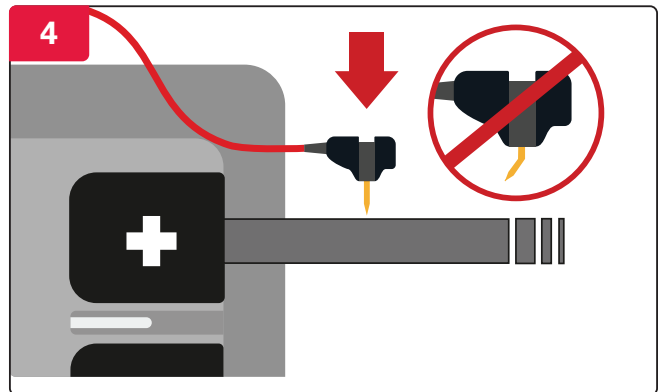

Insert the FlexiTap into the centre of the cable to ensure a good connection.

NOTE: Make sure it is positioned in the centre of the cable, taking care not to bend the pin.

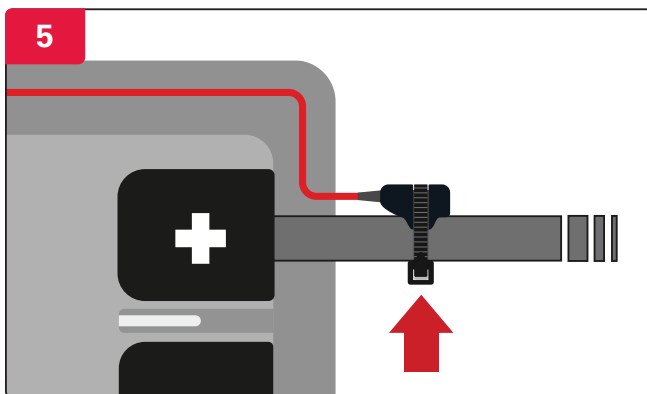

Secure the FlexiTap with a cable tie.

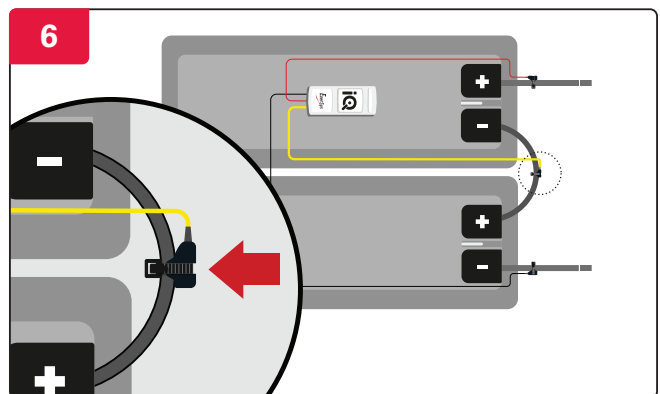

Connect the yellow cable to 12V/24V from the negative terminal.

NOTE: Only connect at 24V for 80V batteries.

INSTALLATION

Installation: Model No. 300Q (cont.)

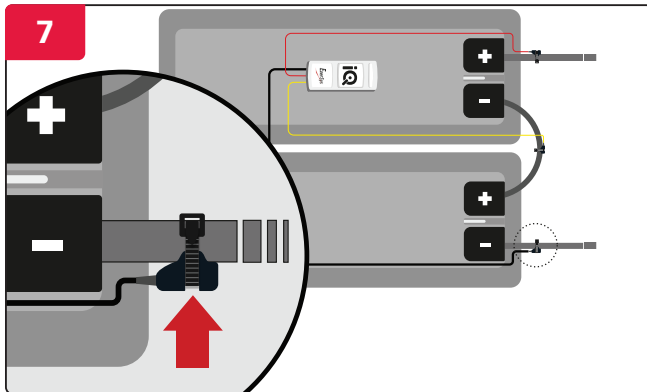

Connect the black cable to the negative terminal.

The black cable must be connected last.

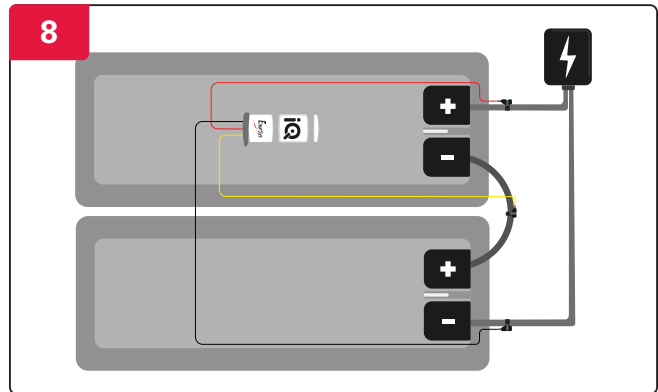

Once the power has been connected, check the following start-up LED sequence.

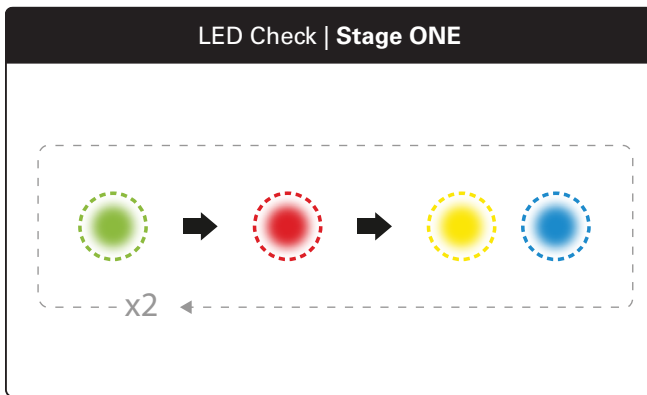

1 green > 1 red > 1 amber & 1 blue
This flashing pattern will repeat twice before the next stage.

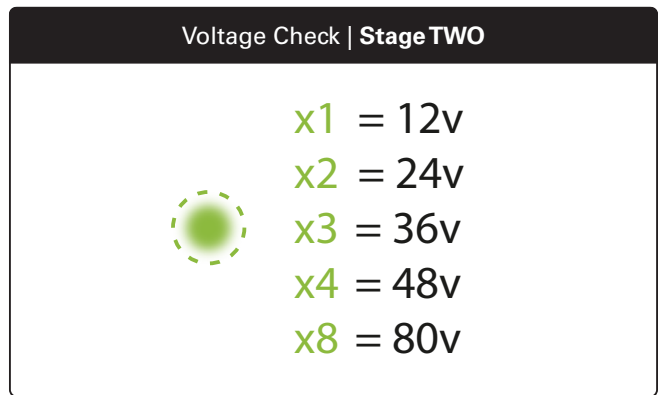

Check the number of flashes for voltage.

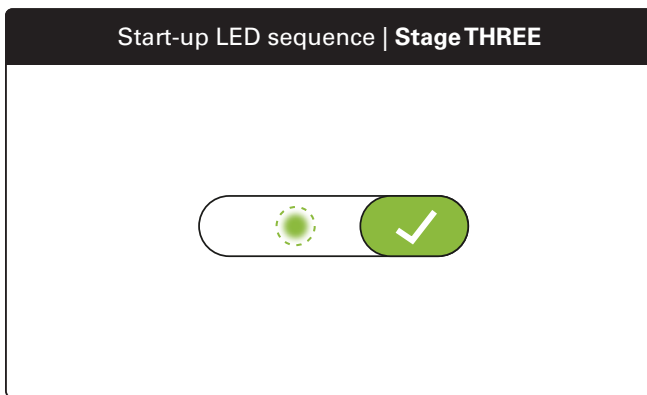

The LED flashes once to show the current battery status.

NOTE: For LED indications please refer to Figure 7 or 8.

INSTALLATION

Installation: Model No. 300B8



The iQ Mini™ battery monitoring device - 300B8 is a battery life monitor that provides real-time status and is intended for use on 12V to 80V TPPL batteries.

The iQ Mini™ battery monitoring device monitors and records cycles, temperatures, and automatically sends this data to a gateway or app for visualisation online.

It provides LED indications for overtemperature and communication. If the status of the battery is OK and the device is working OK, it will flash green every 10 seconds.

INSTALLATION

Installation: Model No. 300B8 (cont.)

Tools required



Sample cells layout

Figure 3: iQ Mini™ Battery Monitoring Device Final Assembly on 24VTPPL Batteries

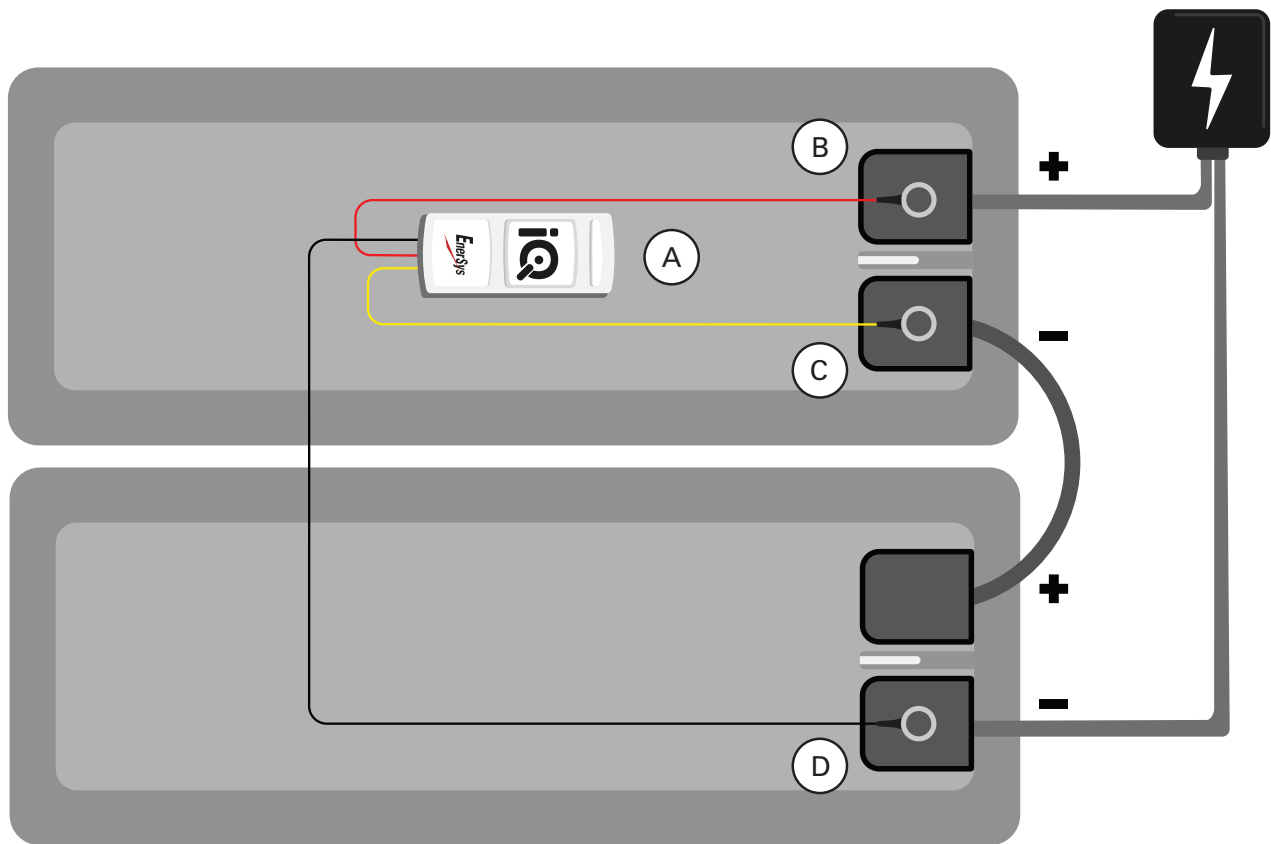

Figure 3



(A) iQ Mini™ Battery Monitoring Device - 300B8

(B) (C) (D) Connection - B8

INSTALLATION

Installation: Model No. 300B8 (cont.)

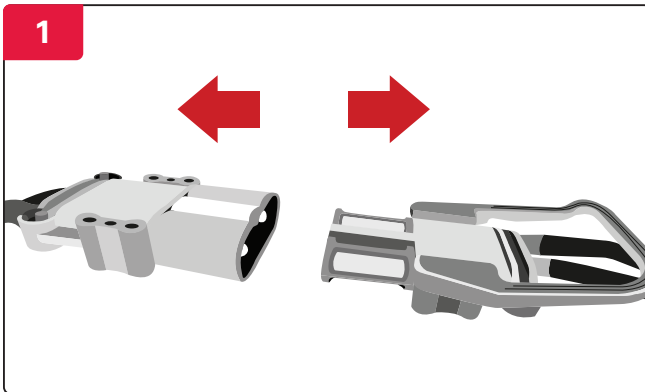

Ensure the voltage is between 2.0 and 2.25 volts per cell before installation.

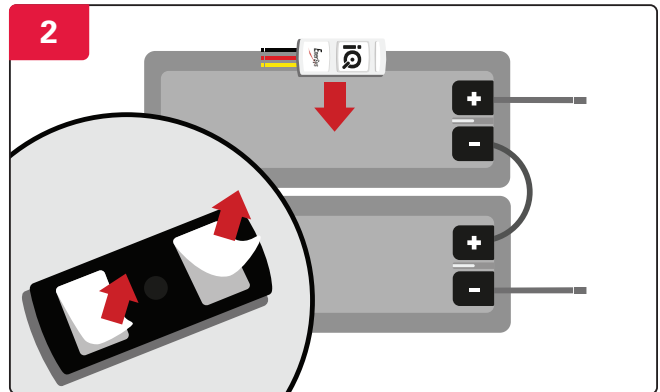

Attach the iQ Mini™ battery monitoring device to the top of the battery.

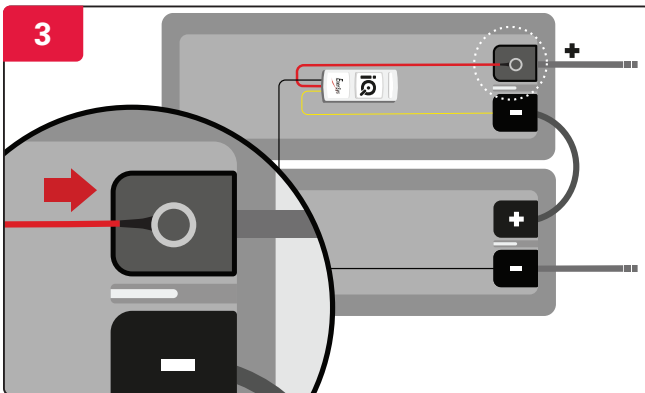

Connect the red cable to the positive terminal.

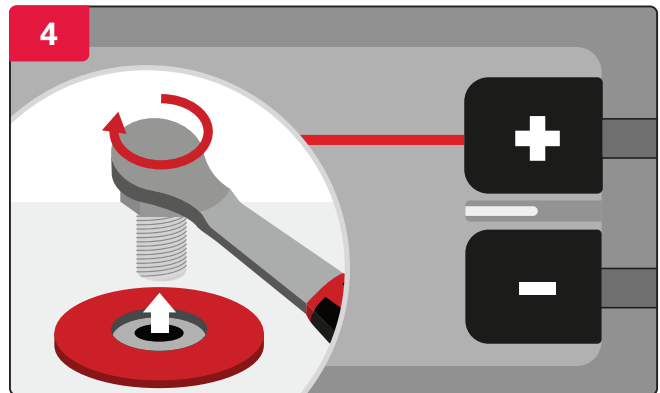

Remove the terminal bolt.

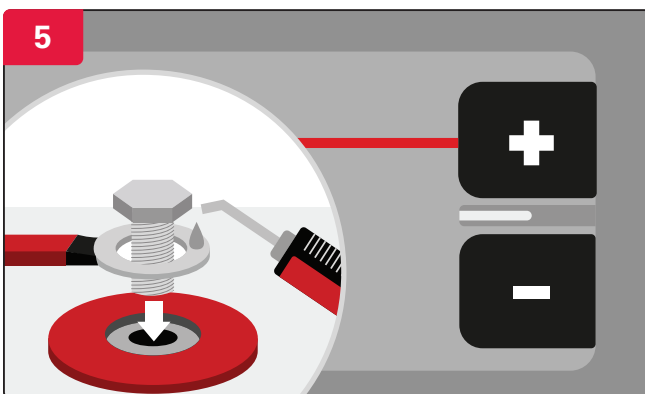

Apply the grease between the bolt and the ring terminal.

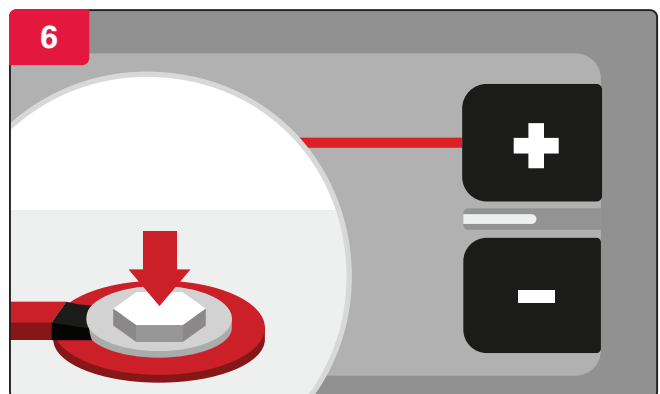

Make sure the bolt is firmly attached to the terminal.

(*N.B. Tighten the bolt to manufacturer-recommended torque settings.)

INSTALLATION

Installation: Model No. 300B8 (cont.)

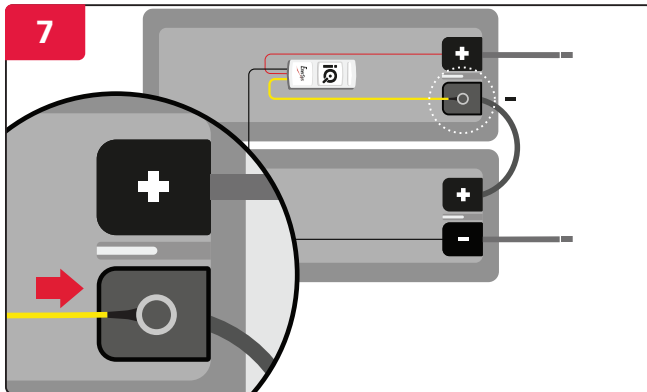

Connect the yellow cable to 12V/24V from the negative terminal.

(*N.B. Only connect at 24V for 80V batteries)

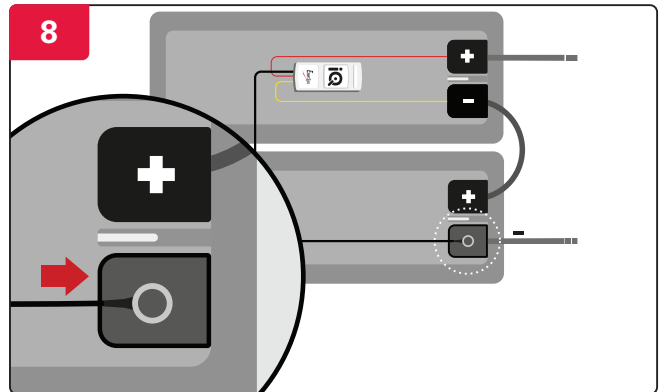

Connect the black cable to the negative terminal.

The black cable must be connected last.

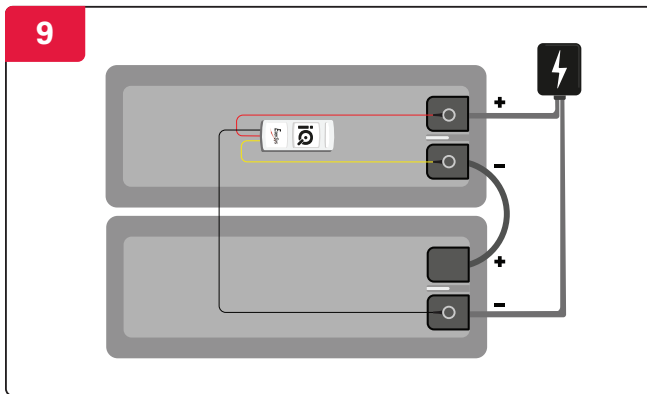

Once the power has been connected, check the following start-up LED sequence.

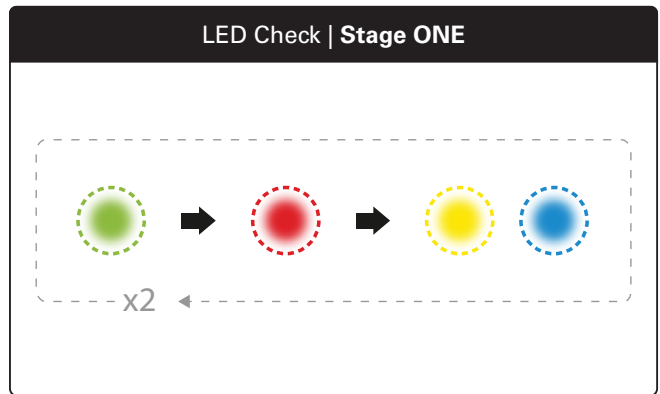

1 green > 1 red > 1 amber & 1 blue
This flashing pattern will repeat twice before the next stage.

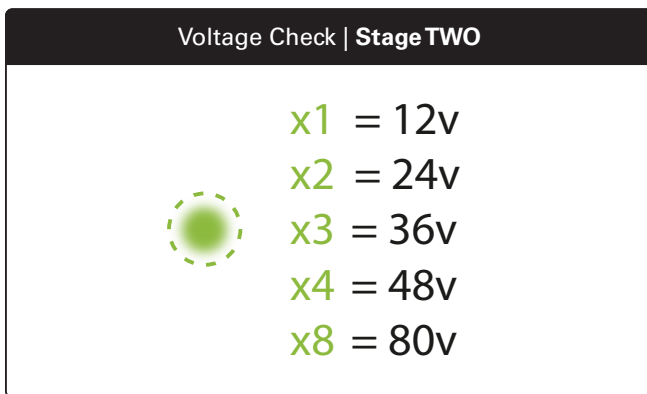

Check the number of flashes for voltage.

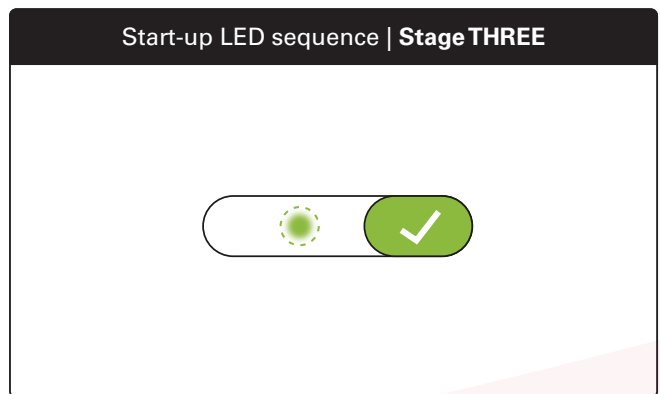

The LED flashes once to show the current battery status.

NOTE: For LED indications please refer to Figure 7 or 8.

INSTALLATION

Installation: Model No. 310Q

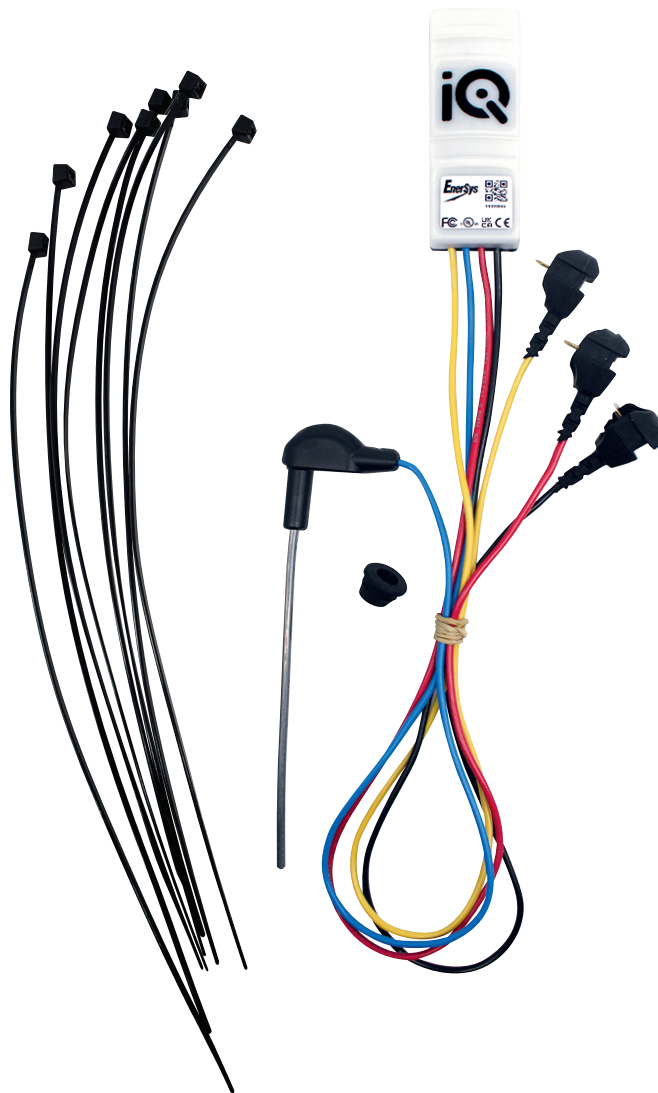

The iQ Mini™ battery monitoring device - 310Q is a battery life monitor that provides real-time status and is intended for use on 12V to 80V flooded batteries.

The iQ Mini™ battery monitoring device monitors and records cycles, temperatures, and automatically sends this data to a gateway or app for visualisation online.

It provides LED indications for electrolyte status, overtemperature and communication. If the electrolyte status of the battery is OK and the device is working, it will flash green.

INSTALLATION

Installation: Model No. 310Q (cont.)

Tools required



Sample cells layout

Figure 4: iQ Mini™ Battery Monitoring Device Final Assembly on 48V Flooded Batteries

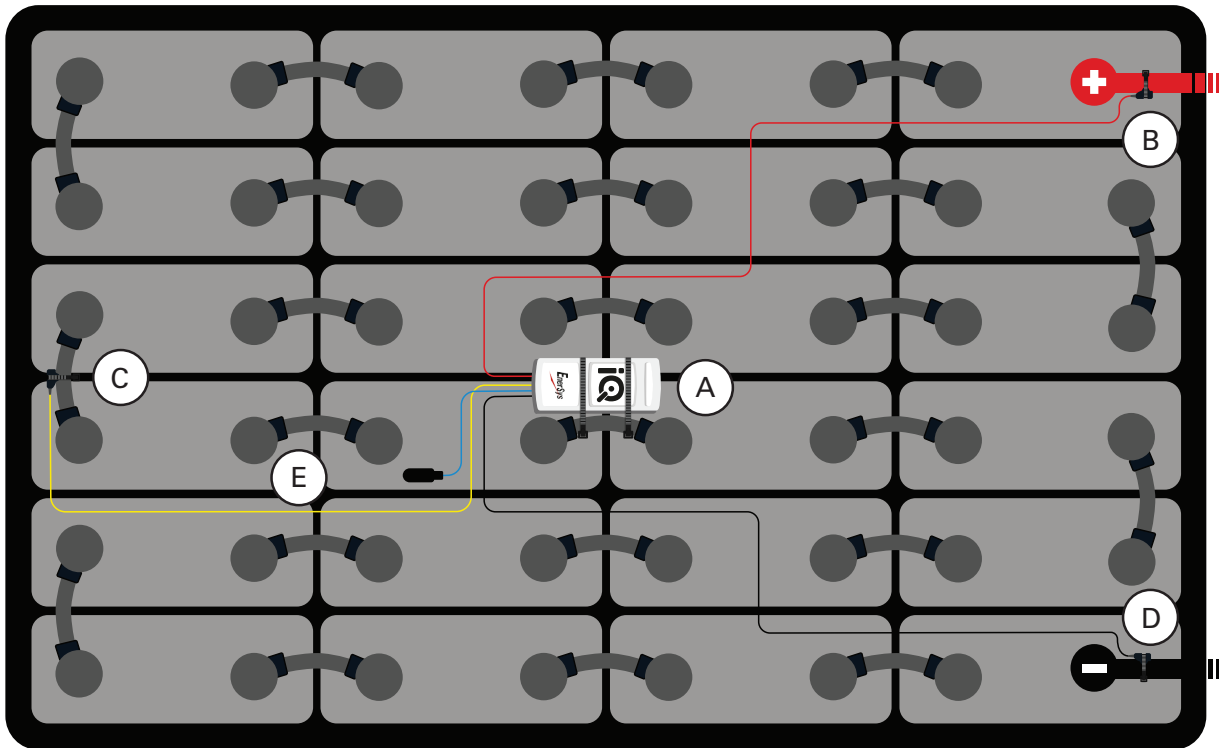
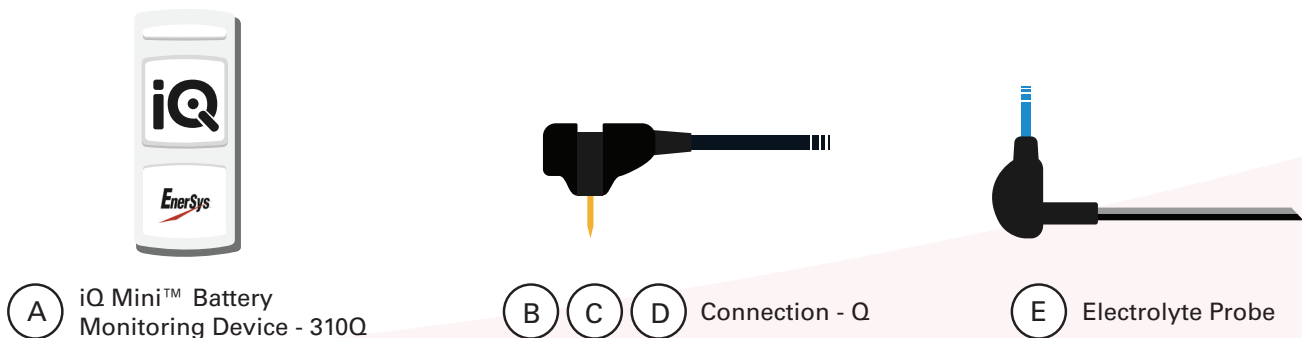
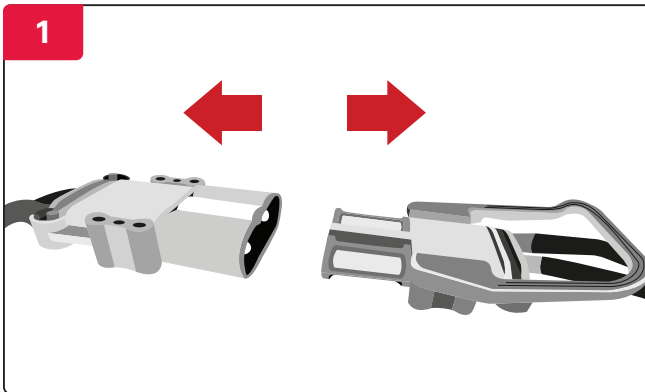

Figure 4



INSTALLATION

Installation: Model No. 310Q (cont.)



Ensure the voltage is between 2.0 and 2.25 volts per cell before installation.

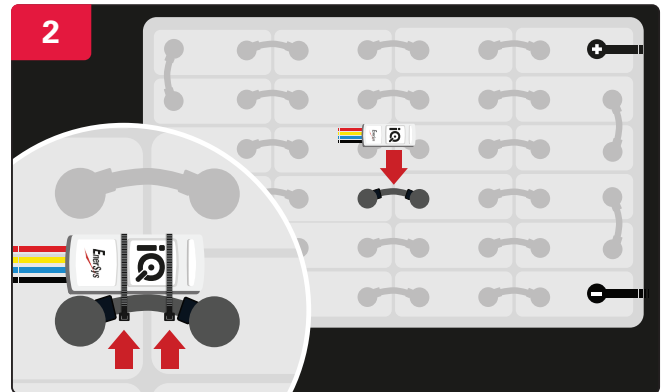

Attach the iQ Mini™ battery monitoring device to the battery and secure it with cable ties.

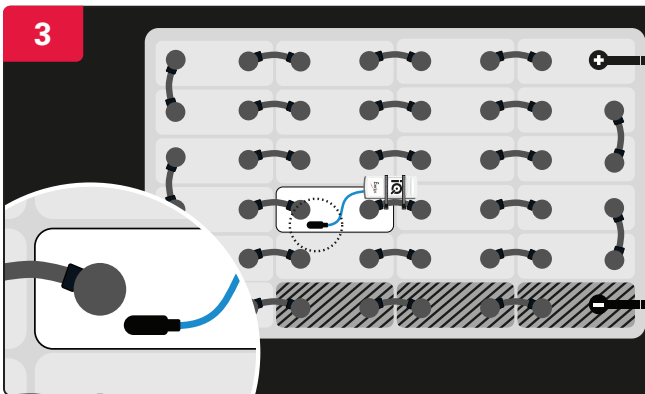

Install the electrolyte probe.

*Probe can be installed in any cells apart from the first three cells from the negative battery terminal.

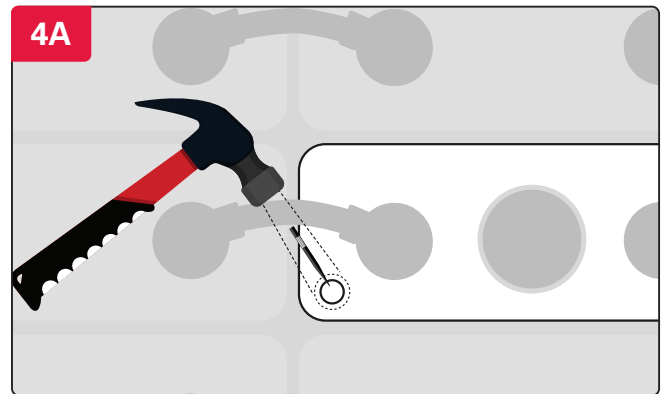

Punch a hole.

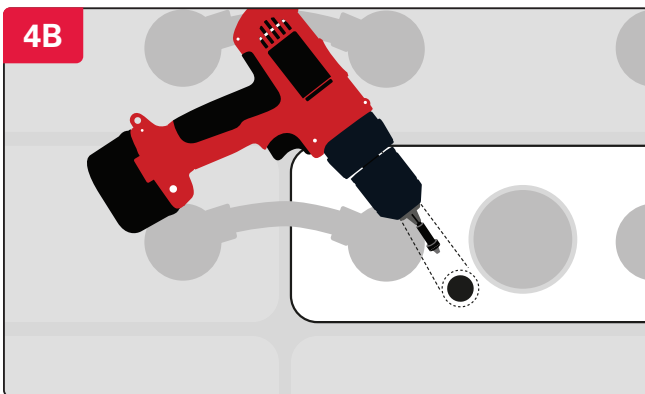

OR drill a hole.

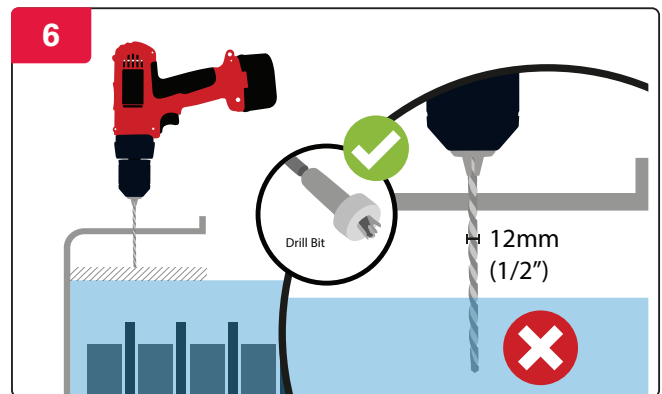

Make sure the drill does not touch the electrolyte.

INSTALLATION

Installation: Model No. 310Q (cont.)

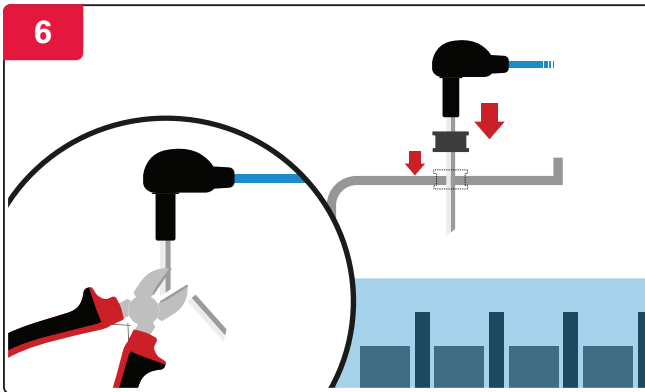

Trim the probe to the correct length and place it into the battery.

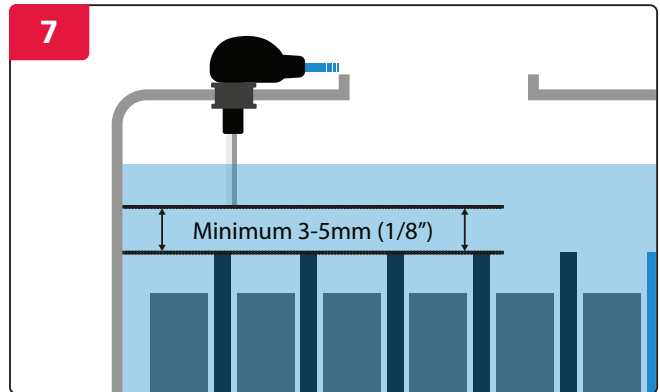

Make sure the probe is at least 3-5 mm (1/8 inch) above the plate.

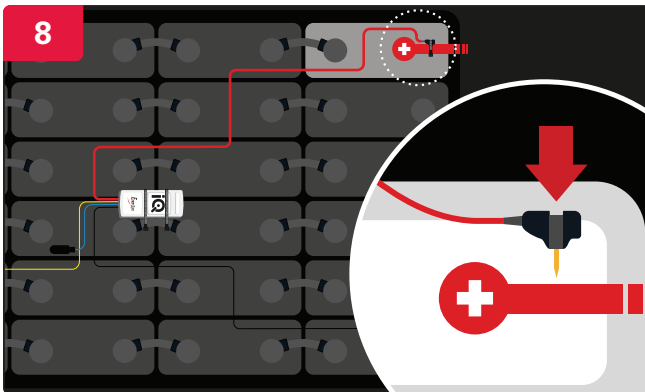

Connect the red cable to the positive terminal.

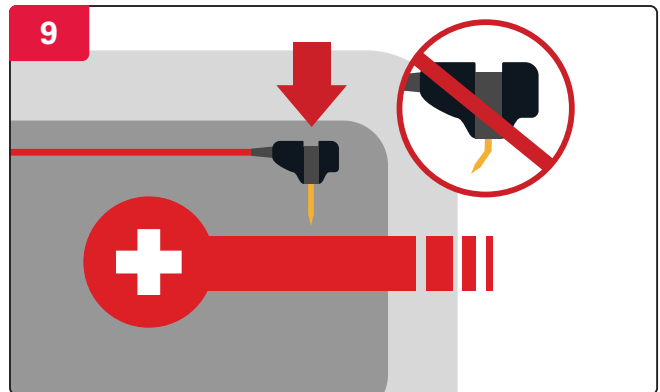

Insert the FlexiTap into the centre of the cable to ensure a good connection.

*Make sure it is positioned in the centre of the cable, taking care not to bend the pin.

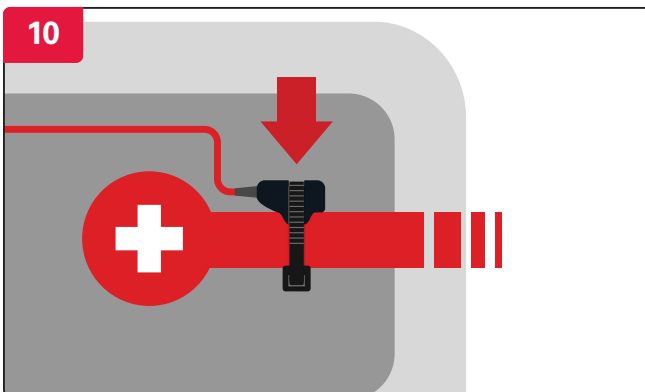

Secure the FlexiTap with a cable tie.

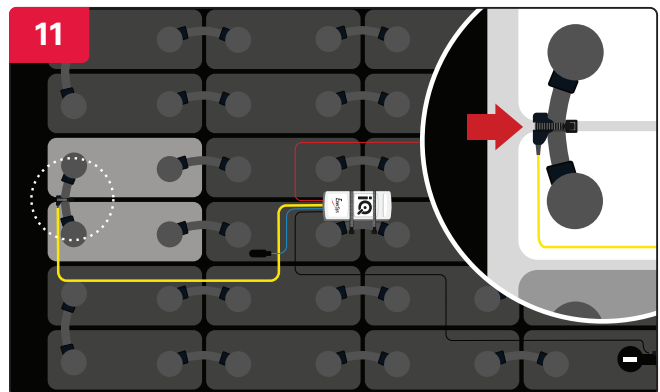

Connect the yellow cable to 12V/24V from the negative terminal.

NOTE: Only connect at 24V for 80V batteries.

INSTALLATION

Installation: Model No. 310Q (cont.)

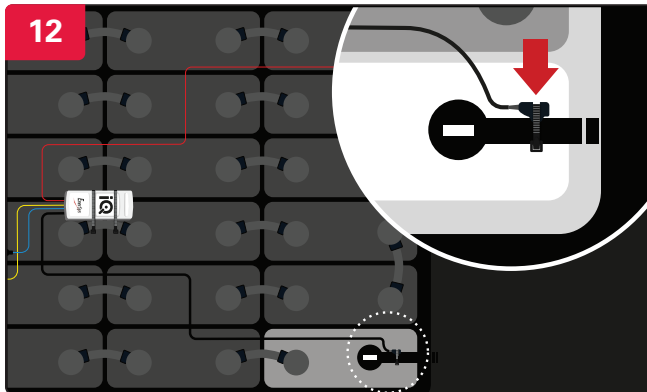

Connect the black cable to the negative terminal. Once the power has been connected, check the following start-up LED sequence.

The black cable must be connected last.

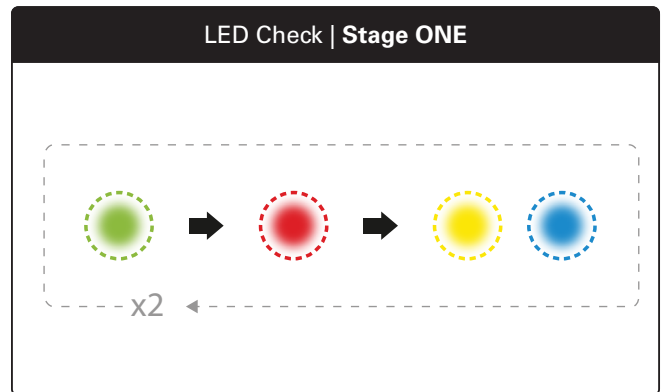

1 green > 1 red > 1 amber & 1 blue
This flashing pattern will repeat twice before the next stage.

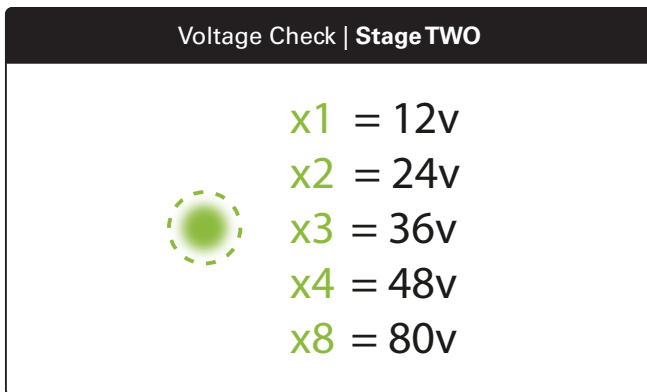

Check the number of flashes for voltage.

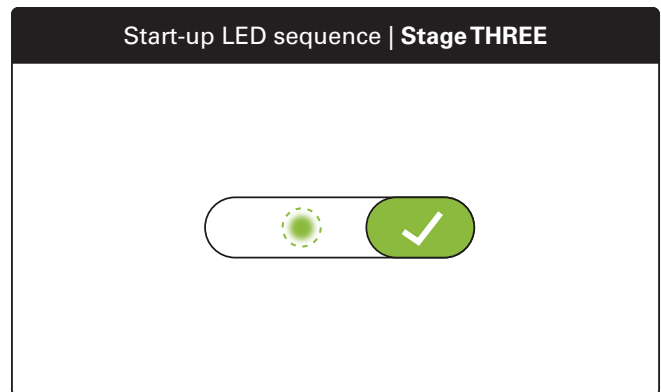

The LED flashes once to show the current battery status.

NOTE: For LED indications please refer to Figure 7 or 8.

INSTALLATION

Installation: Model No. 310S



The iQ Mini™ battery monitoring device - 310S is a battery life monitor that provides real-time status and is intended for use on 12V to 80V flooded batteries.

The iQ Mini™ battery monitoring device monitors and records cycles, temperatures, and automatically sends this data to a gateway or app for visualisation online.

It provides LED indications for electrolyte status, overtemperature and communication. If the electrolyte status of the battery is OK and the device is working, it will flash green.

INSTALLATION

Installation: Model No. 310S (cont.)

Tools required

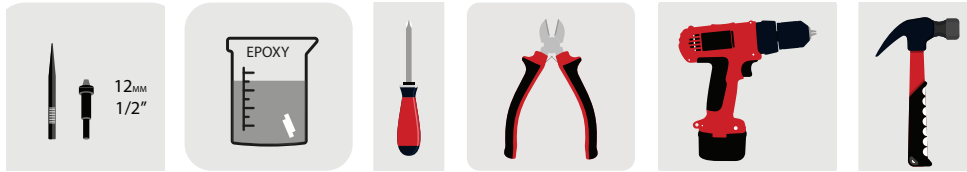

Sample cells layout

Figure 5: iQ Mini™ Battery Monitoring Device Final Assembly on 48V Flooded Batteries

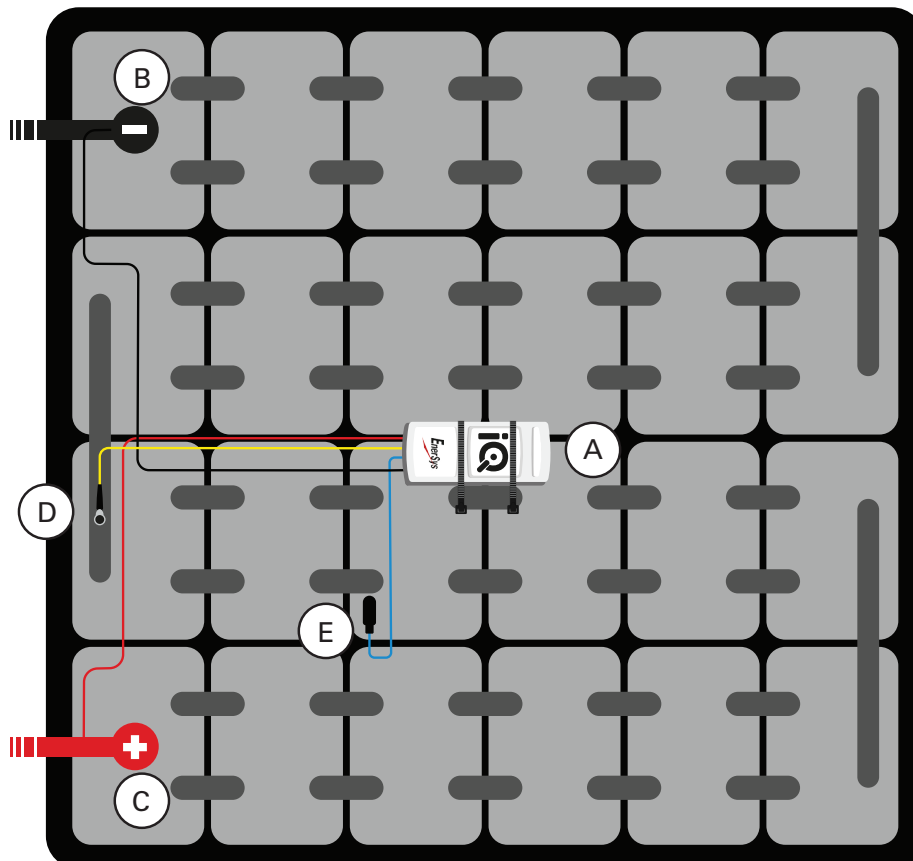

Figure 5



(A) iQ Mini™ Battery Monitoring Device - 310S



(B) (C) (D) Connection - S



(E) Electrolyte Probe

INSTALLATION

Installation: Model No. 310S (cont.)

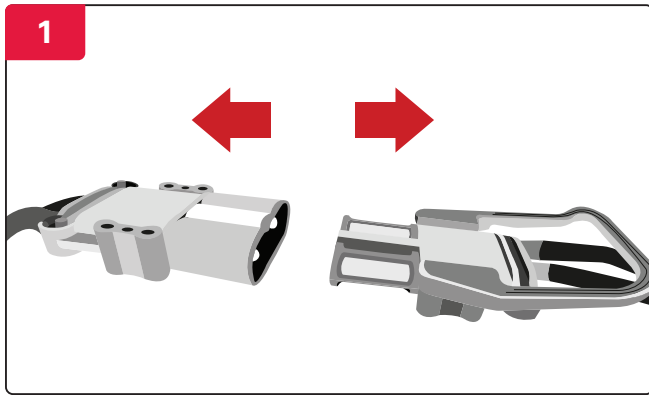

Ensure the voltage is between 2.0 and 2.25 volts per cell before installation.

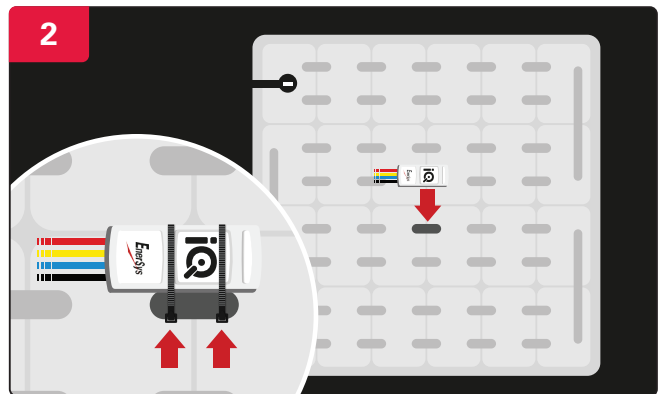

Attach the iQ Mini™ battery monitoring device to the battery and secure it with cable ties.

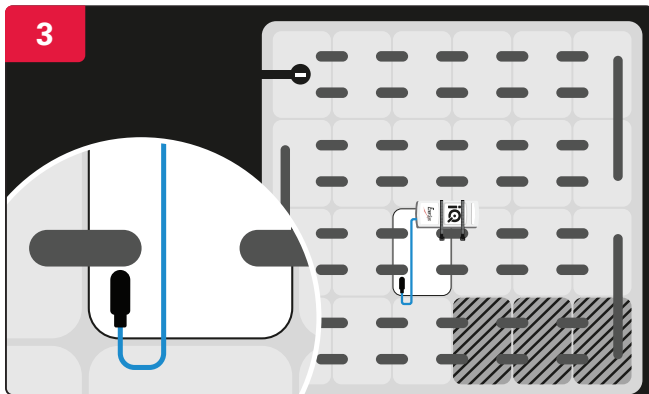

Install the electrolyte probe.

NOTE: Probe can be installed in any cells apart from the first three cells from the negative battery terminal.

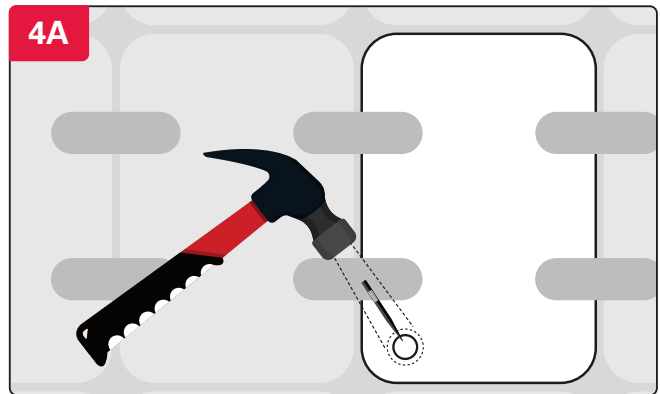

Punch a hole.

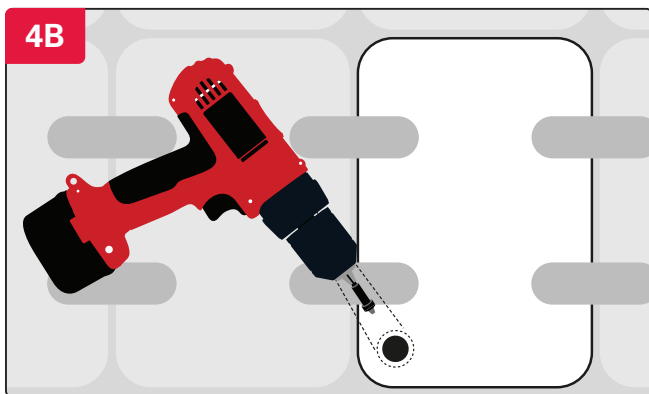

OR drill a hole.

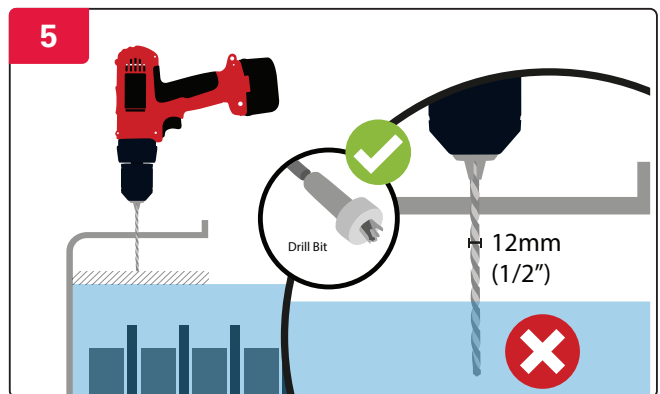

Make sure the drill does not touch the electrolyte.

INSTALLATION

Installation: Model No. 310S (cont.)

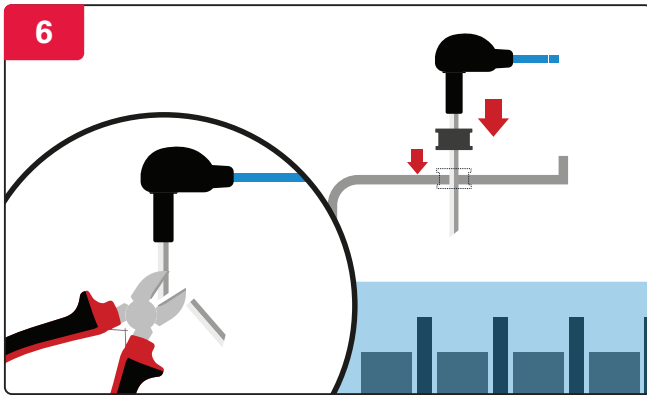

Trim the probe to the correct length and place it into the battery.

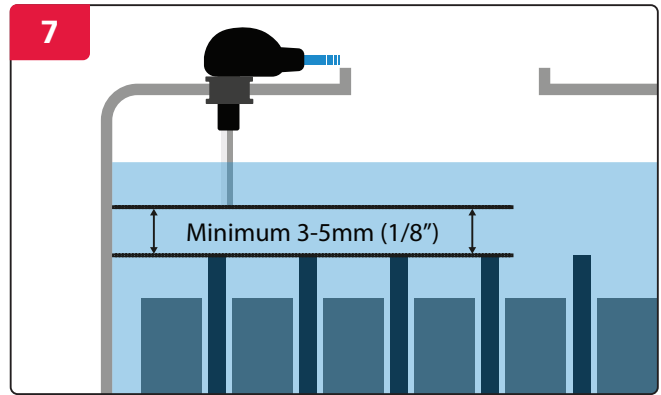

Make sure the probe is at least 3–5mm (1/8 inch) above the plate.

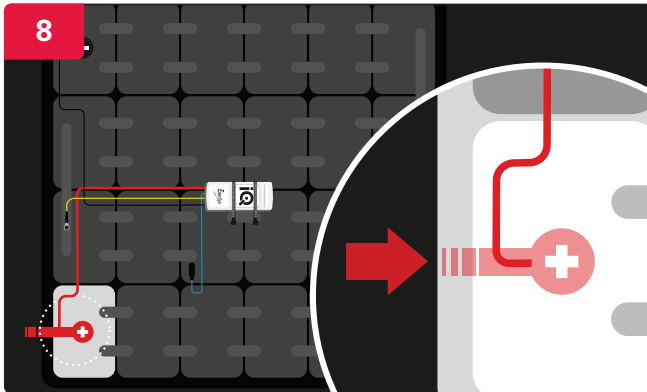

Connect the red cable to the positive terminal.

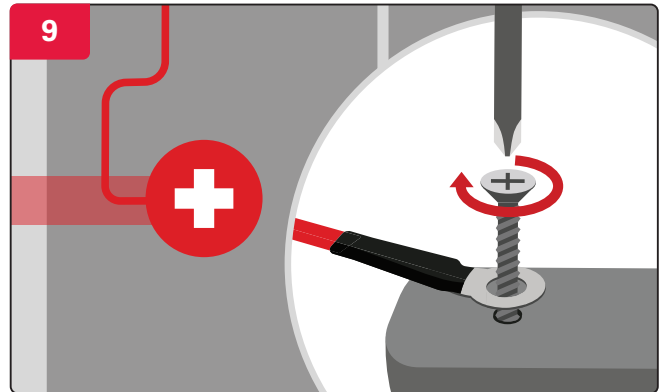

Screw the M4 connection to the terminal.

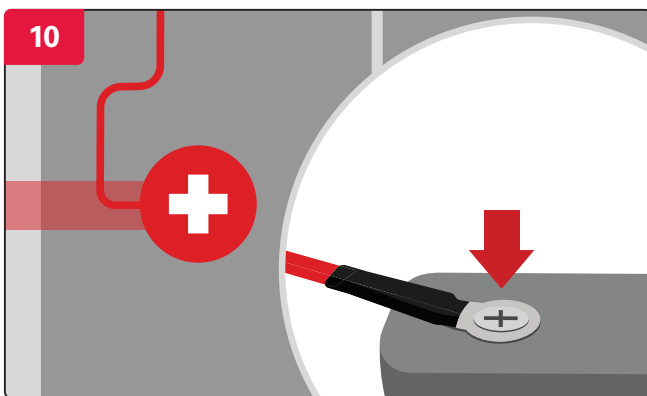

Make sure the M4 connection is firmly attached to the battery.

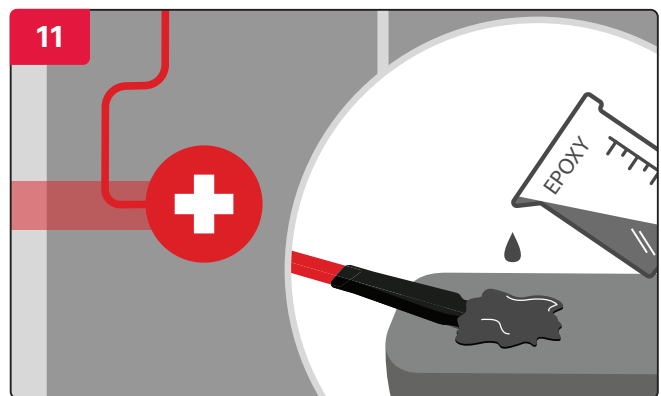

Apply epoxy on top of the screw.

INSTALLATION

Installation: Model No. 310S (cont.)

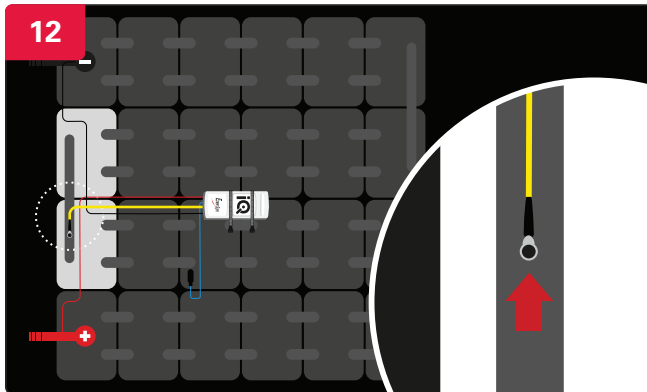

Connect the yellow cable to 12V/24V from the negative terminal.

NOTE: Only connect at 24V for 80V batteries.

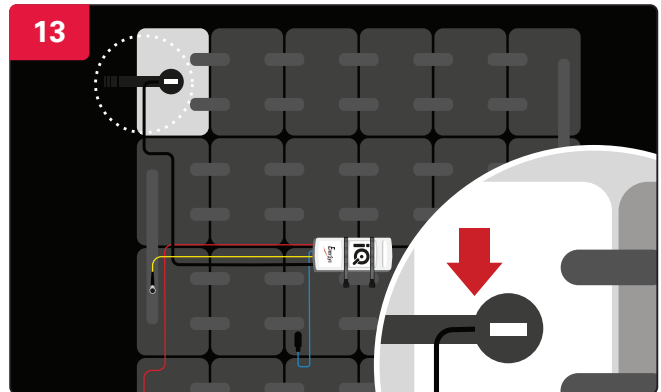

Connect the black cable to the negative terminal.

The black cable must be connected last.

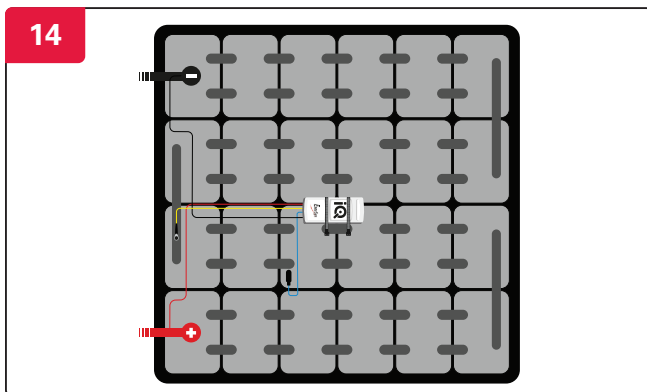

Once the power has been connected, check the following start-up LED sequence.

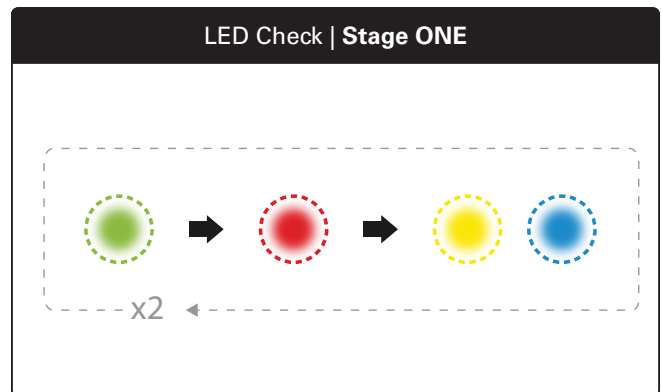

1 green > 1 red > 1 amber & 1 blue
This flashing pattern will repeat twice before the next stage.

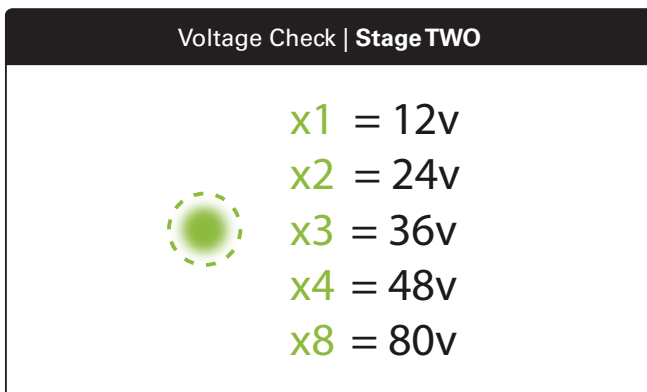

Check the number of flashes for voltage.

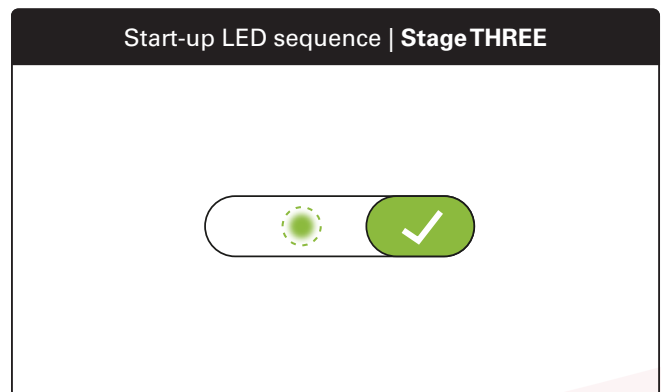

The LED flashes once to show the current battery status.

NOTE: For LED indications please refer to Figure 7 or 8.

INSTALLATION

Installation: Model No. 301Q

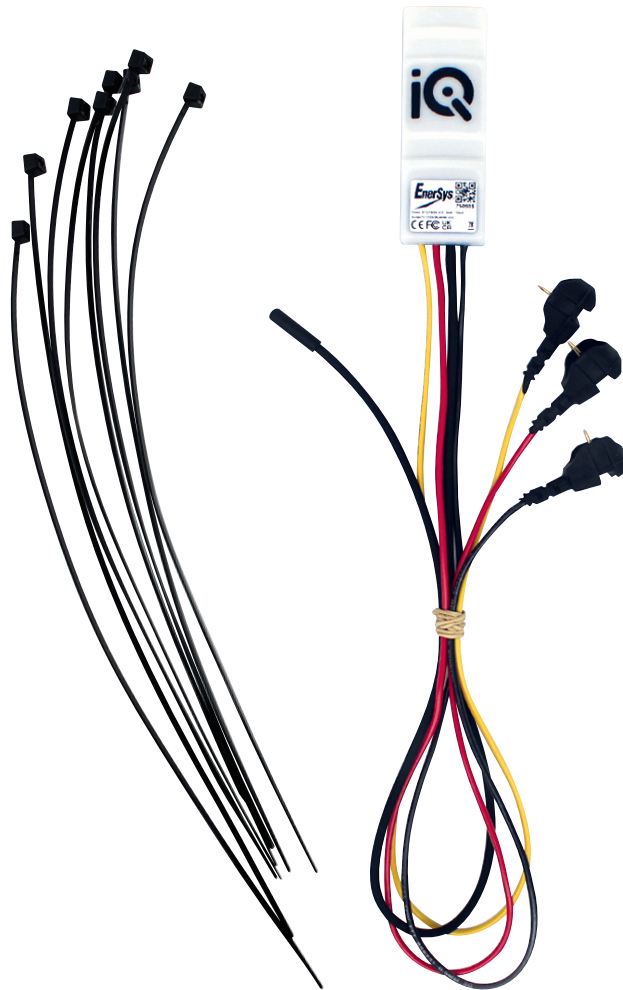

The iQ Mini™ battery monitoring device - 301Q is a battery life monitor that provides real-time status and is intended for use on 12V to 80V TPPL batteries.

The iQ Mini™ battery monitoring device monitors and records cycles, temperatures, and automatically sends this data to a gateway or app for visualisation online.

It provides LED indications for overtemperature and communication. This variant has an external temperature sensor.

INSTALLATION

Installation: Model No. 301Q (cont.)

Tools required

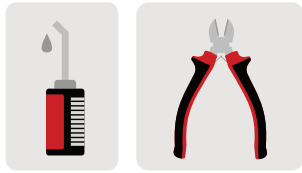

Sample cells layout

Figure 6: iQ Mini™ Battery Monitoring Device Final Assembly on 48VTPPL Batteries

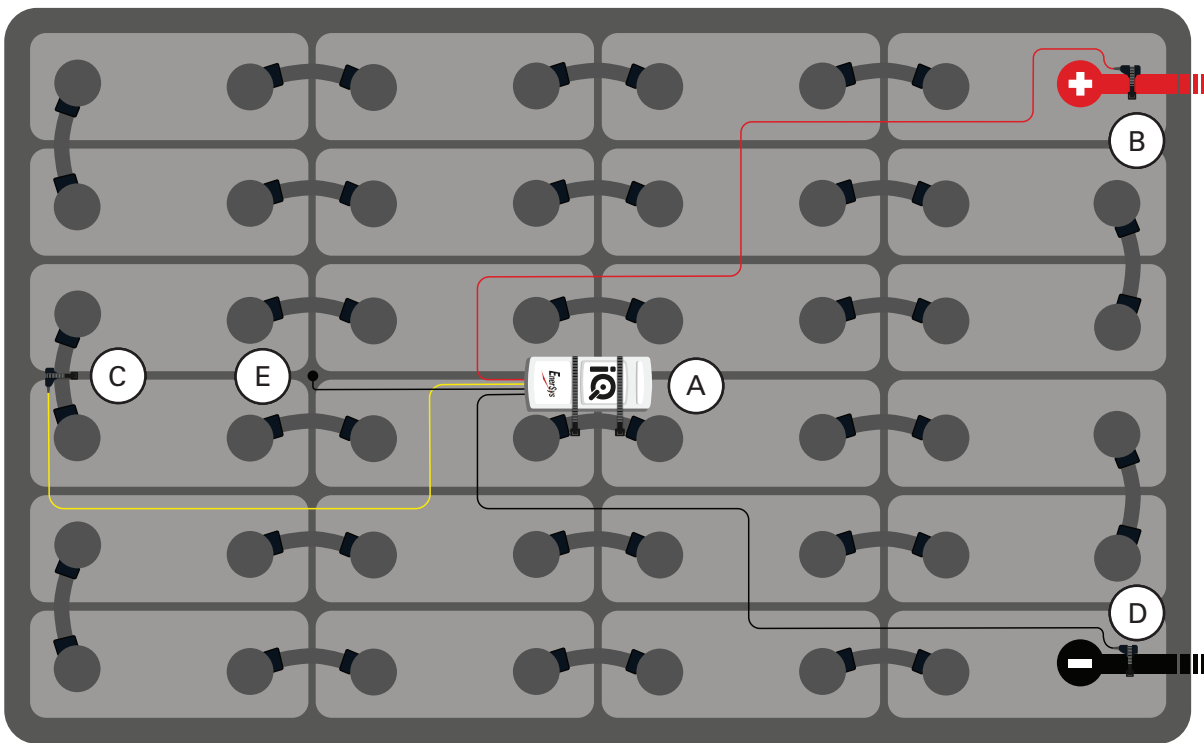
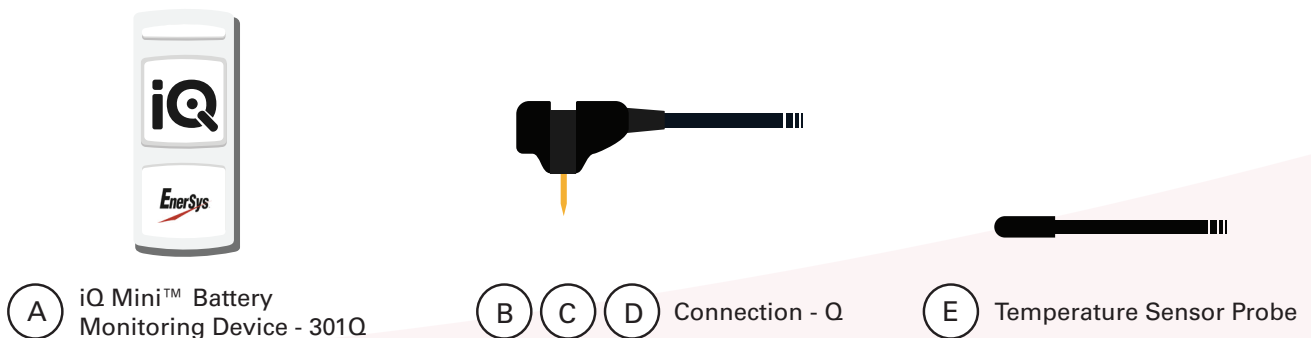
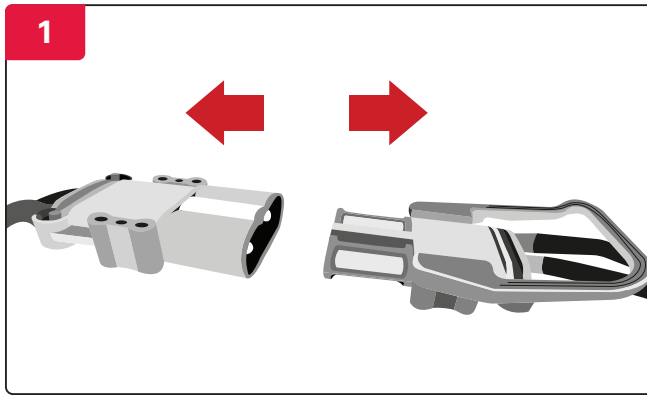

Figure 6



INSTALLATION

Installation: Model No. 301Q (cont.)



Ensure the voltage is between 2.0 and 2.25 volts per cell before installation.

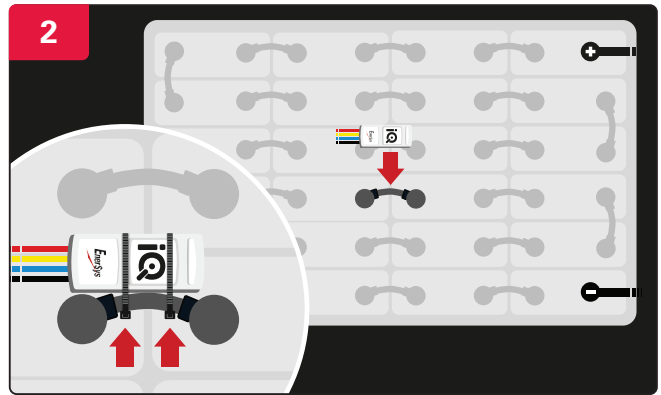

Attach the iQ Mini™ battery monitoring device to the battery and secure it with cable ties.

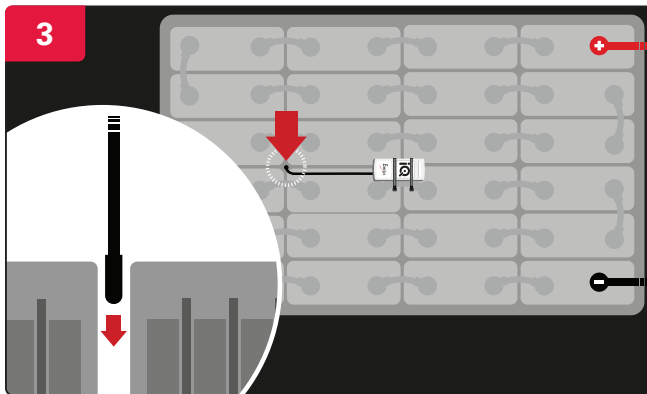

Install the temperature sensor probe.

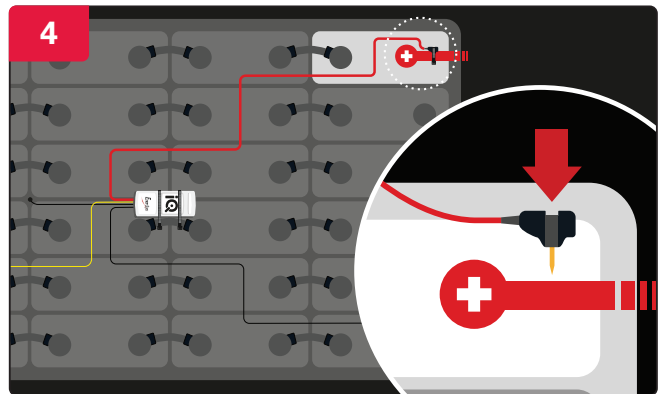

Connect the red cable to the positive terminal.

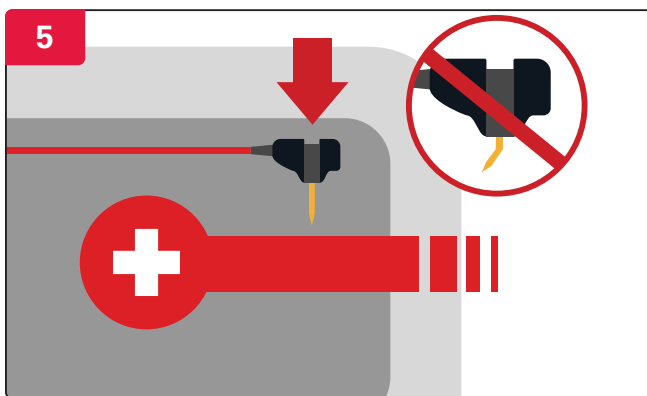

Insert the FlexiTap into the centre of the cable to ensure a good connection.

*Make sure it is positioned in the centre of the cable, taking care not to bend the pin.

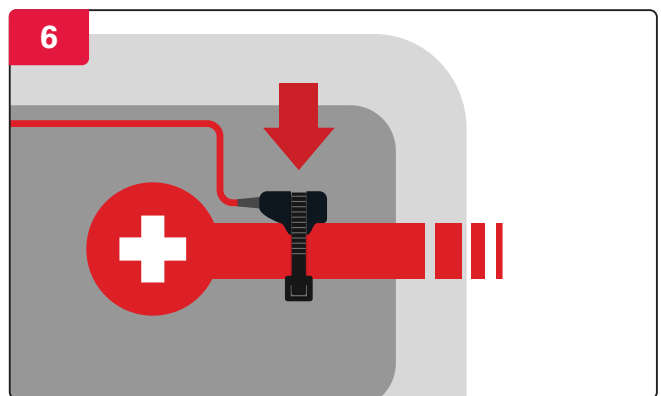

Secure the FlexiTap with a cable tie.

INSTALLATION

Installation: Model No. 301Q (cont.)

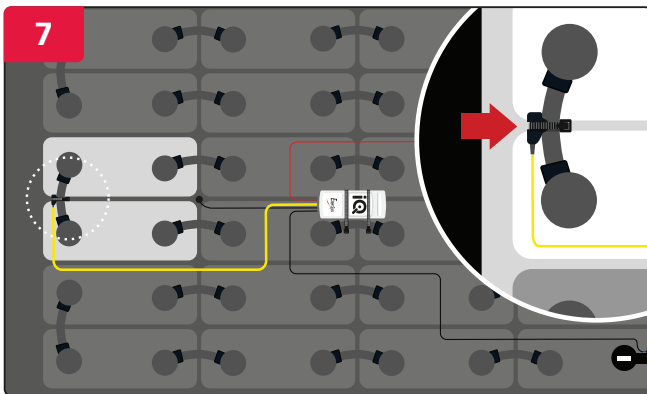

Connect the yellow cable to 12V/24V from the negative terminal.

(*N.B. Only connect at 24V for 80V batteries)

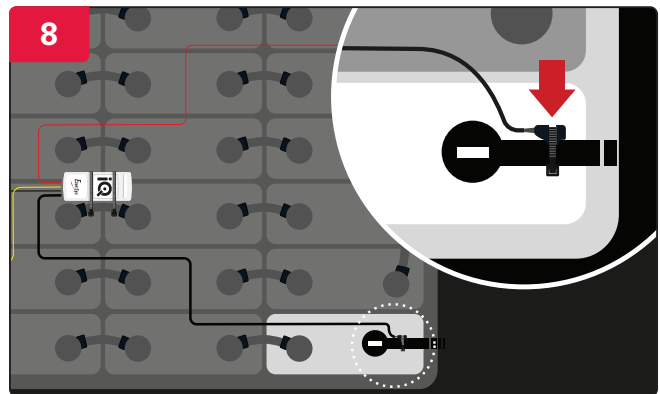

Connect the black cable to the negative terminal.

The black cable must be connected last.

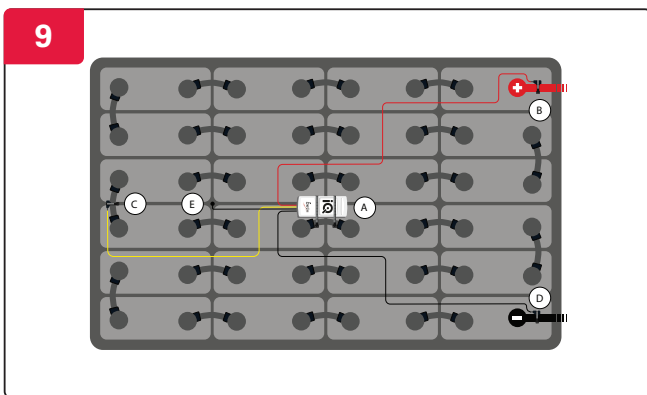

Once the power has been connected, check the following start-up LED sequence.

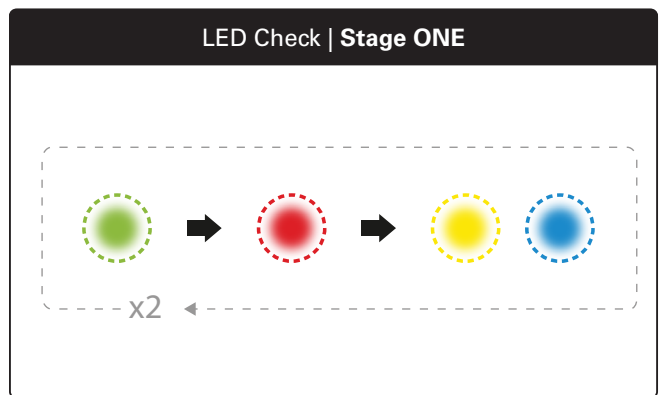

1 green > 1 red > 1 amber & 1 blue
This flashing pattern will repeat twice before the next stage.

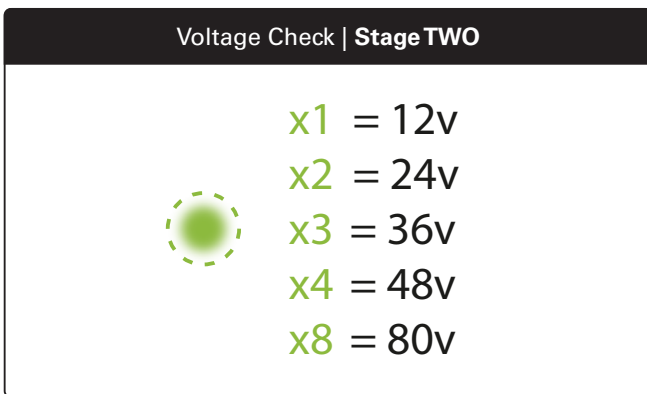

Check the number of flashes for voltage.

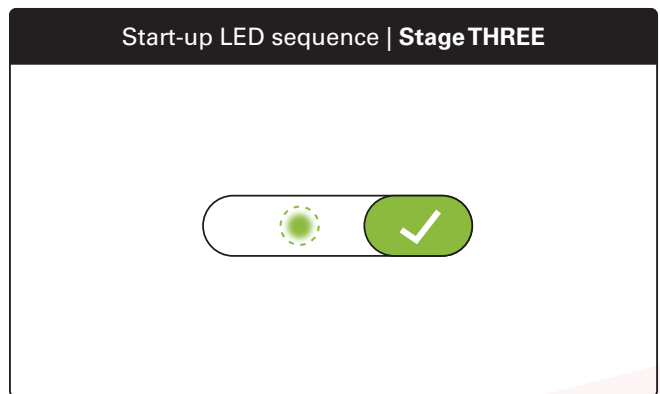

The LED flashes once to show the current battery status.

NOTE: For LED indications please refer to Figure 7 or 8.

VISUAL LED INDICATION

Visual LED Indication

Automatic Voltage Detection

The iQ Mini™ battery monitoring device automatically detects the battery voltage. This is indicated by the green LED flash just after the initial boot-up sequence. Refer to the table below for the voltage detected by the iQ Mini™ battery monitoring device.

IMPORTANT: For the iQ Mini™ battery monitoring device to detect the correct voltage, the volts per cell must be between 2.0 and 2.25 vpc during installation.

Tap Connection

Number of Flashes	Cells Sensed (Cells)	Nominal Voltage (Voltage)
1	6	12
2	12	24
3	18	36
4	24	48
8	40	80

72V needs to be ordered separately.

LED Indications

Figure 7: LED Indications for 300Q, 300B8 & 301Q

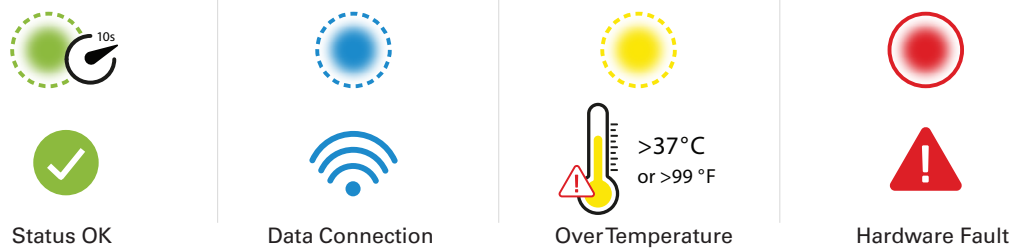

Figure 8: LED Indications for 310Q & 310S

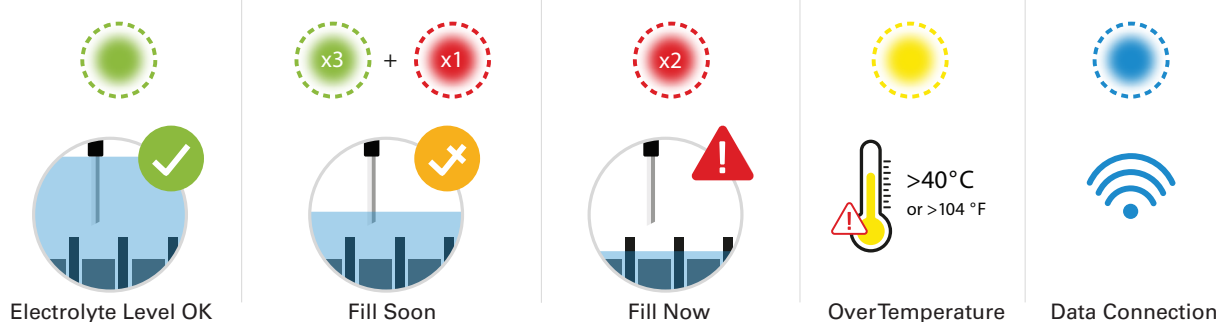
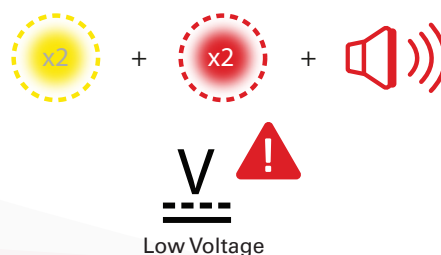

Figure 9: Low Voltage Alert Indications



CONNECTIVITY

Connectivity

iQ gateway™ Battery Data Transmitter



The iQ GATEway™ battery data transmitter automatically collects the data from any iQ Mini™ battery monitoring devices that are within range and uploads the data directly to the online portal. This data is available in real time and shows the status of the connected devices.

CONNECTIVITY

Connectivity (cont.)

Tools required

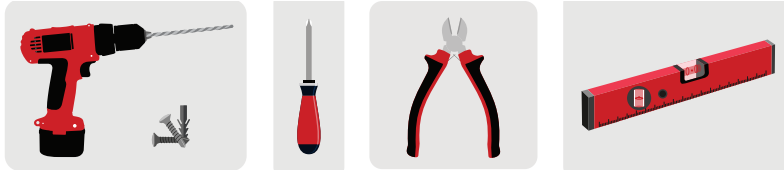

iQ GATEway™ BATTERY DATA TRANSMITTER Overall Dimensions

Figure106: iQ GATEway™ Battery Data Transmitter Dimensions

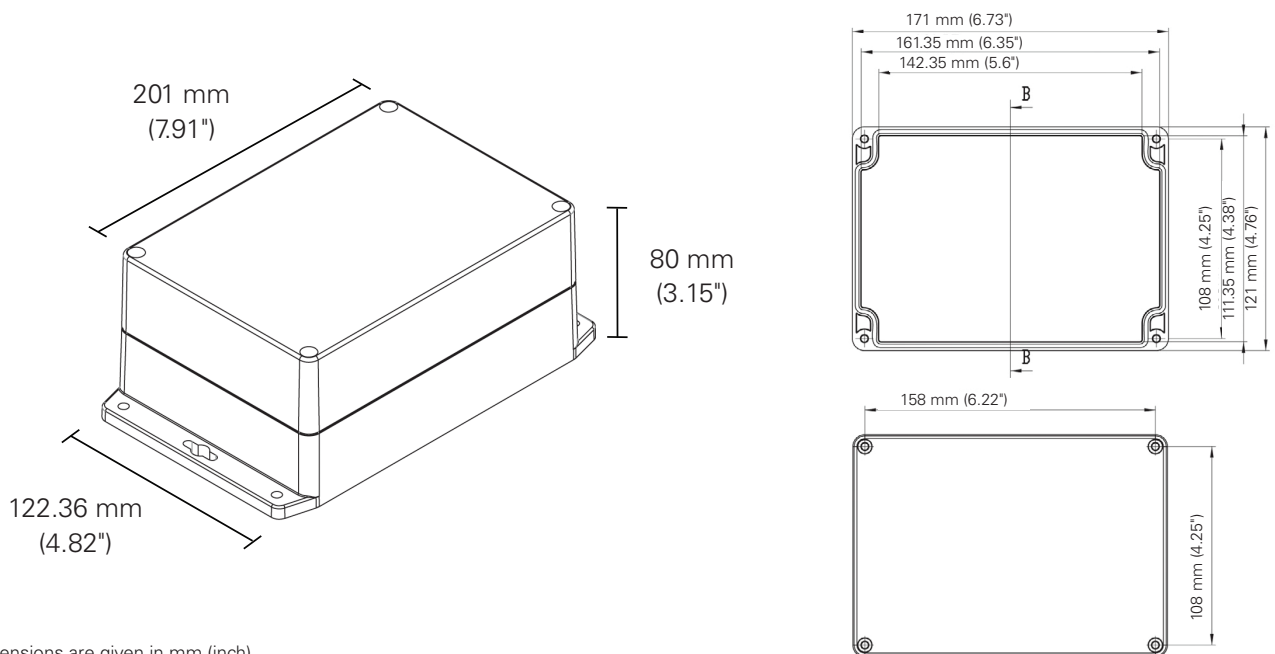

*All dimensions are given in mm (inch).

iQ GATEway™ Battery Data Transmitter Installation

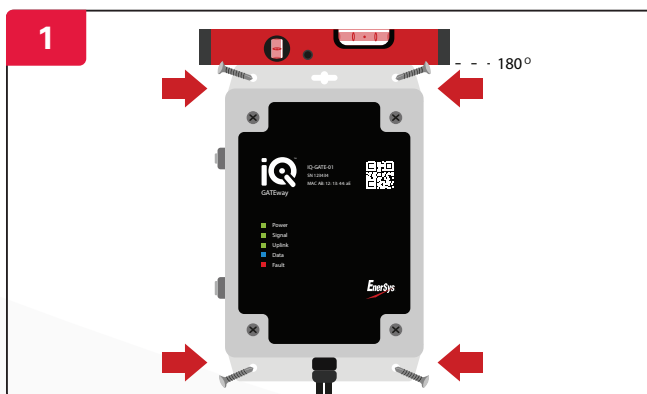

1 Mount the control box to the wall using four screws/anchors and a level. Make sure it is firmly attached to the wall.

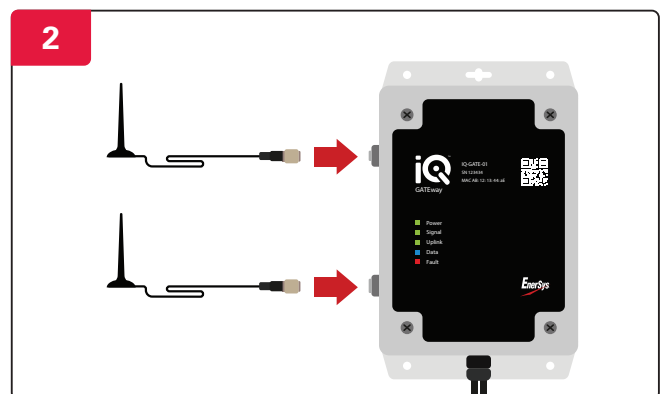

2 Attach antennae to the iQ GATEway™ battery data transmitter.

CONNECTIVITY

Connectivity (cont.)

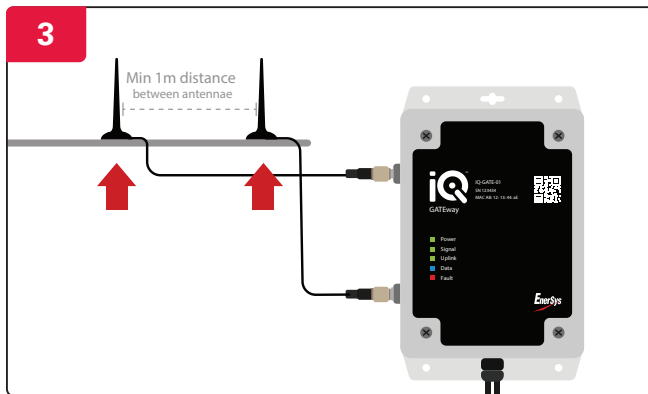

Place both antennae as high as possible to maximise signal.

NOTE: Keep at least 1m distance between the antennae.

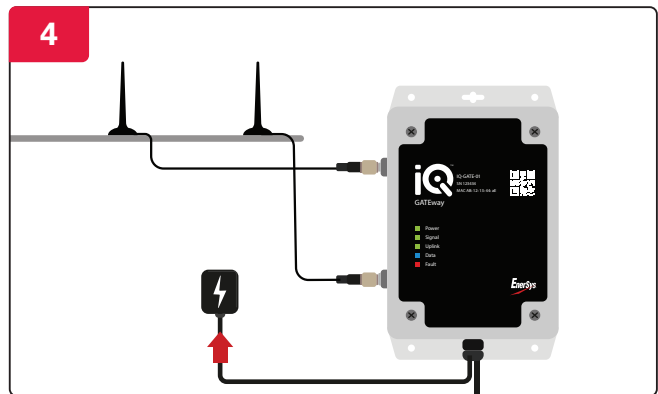

Powering the device.

Start-up LED Sequence



Stage One Power

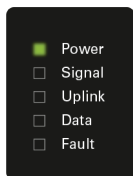

Solid green when it is connected to the power.



Stage Two Signal



Green slow flash when it is connecting to the signal.



Stage Three Signal

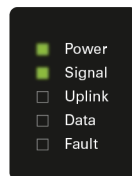

Solid green when there is a good signal.
*Please refer to the FAQs section if the signal is unstable.



Stage Four Uplink

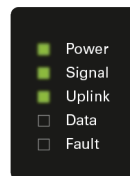

Solid green when it connects to the internet.



Stage Five Data

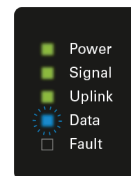

Blue slow flash when the receiver is active.
*Please refer to the FAQs section if the blue LED light is not flashing.

*Please refer to the FAQs section if the solid red fault light is on.

Connectivity (cont.)

Installation Locations

✓ Recommended Locations	✗ Avoid Locations
Battery Room	Exterior Location
Main Charging Area	Humid Areas (e.g. Boiler Room)
Central Location	Enclosed Spaces
Central Doorway	Metal Clad Areas

Frequently Asked Questions (FAQs)

iQ Mini™ Battery Monitoring Device

Q1

What data does the iQ Mini™ battery monitoring device monitor and record?

The iQ Mini™ battery monitoring device monitors and records battery voltage, temperature, electrolyte level, and battery status (i.e. real-time charge/discharge status). Additionally, it monitors and records cycles, average and min/max temperatures, min/max voltages, life history, and any abuse of the battery – overtemperature, over-discharge, and low electrolyte. This data can be visualized online or with the app and uploaded via a gateway.

Q2

I have connected the wires but there are no lit LEDs on the iQ Mini™ battery monitoring device.

Check that the connections have been made in the correct sequence across the correct voltage. If these are all correct, the device may be defective. Contact your local EnerSys® service location.

Q3

What is the purpose of the green LED flash during the initial boot-up sequence?

The purpose of the green LED flash during the initial boot-up sequence is to indicate the detected battery voltage. The number of green LED flashes corresponds to the voltage of the battery. For example, one green flash indicates a 12V battery, two green flashes indicate a 24V battery, and so on, up to eight green flashes indicating an 80V battery. This LED indication helps users verify that the iQ Mini™ battery monitoring device has correctly detected the battery voltage and is ready for operation. When installing the iQ Mini™ battery monitoring device, this must be checked.

Q4

I have connected the device and the iQ Mini™ battery monitoring device powers up, but the number of green flashes does not match the voltage of the battery.

This may mean that the iQ Mini™ battery monitoring device has been powered up in the incorrect sequence. Disconnect the wires and reinstall, ensuring that the yellow wire is connected before the red and black wires. The iQ Mini™ battery monitoring device must be installed when the voltage is between 2.0 and 2.25 volts per cell.

Q5

I have installed the electrolyte probe, but the LED indication is not correct.

First, ensure that the electrolyte probe is not installed in the first 3 cells from the negative take-off lead. The probe must not be touching any plates or separators inside the cell. If this has been confirmed and the problem persists, contact your local EnerSys® service location.

Q6

There is a rapid flashing amber LED on the iQ Mini™ battery monitoring device – what does this mean?

The flashing amber means the voltage range is not correct. Ensure that the red and black wires are connected across 12V, 18V, or 24V only. It can also mean that the voltage is not stable. Ensure that the charger has been disconnected and the battery has had enough time to reach a voltage between 2.0 and 2.25 volts per cell.

Q7

There is a flashing red indication on the iQ Mini™ battery monitoring device – what does this mean?

Flashing red indicates that the electrolyte level is low.

Q8

There is a solid red LED indication on the iQ Mini™ battery monitoring device – what does this mean?

The red LED indicates a fault – please contact your local EnerSys® service location for support.

Q9

I have installed the gateway and the iQ Mini™ battery monitoring device, but I can't see the real-time status online.

The gateway must be assigned to the site online before it is installed and powered up. For further information contact your local EnerSys® service location.



FAQS & SPARE PARTS

Frequently Asked Questions (FAQs) (cont.)

iQ GATEway™ Battery Data Transmitter

- Q1 **The signal LED does not turn solid green.**
 This means that the signal is insufficient. Transfer the gateway to a location where the signal is better.
- Q2 **There is a solid red LED on the gateway – what does this mean?**
 A solid red LED means the gateway is faulty. Please contact your local EnerSys® service location.
- Q3 **I've powered up the gateway, but none of the LEDs are turning on.**
 Check the plug is correctly connected and turned on. If the problem persists contact your local EnerSys® service location.
- Q4 **The blue LED is not flashing – what does this mean?**
 This means the receiver has not been activated and data is not being uploaded. Please contact your local EnerSys® service location.

Spare Parts

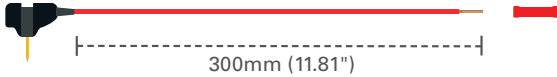
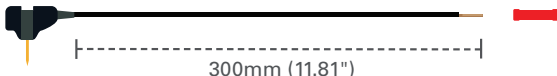
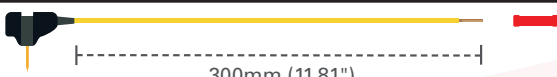

iQ Mini™ Battery Monitoring Device	
Part no.	Parts
IQ-300 iQ Mini™ Battery Monitoring Device TPPL w/o External Temperature Probe	
IQ-310 iQ Mini™ Battery Monitoring Device Flooded w/o External Temperature Probe	
IQ-301 iQ Mini™ Battery Monitoring Device TPPL w/ External Temperature Probe	

Terminal Connection Q - FlexiTap	
Part no.	Parts
IQ-RFQ Terminal Connection FlexiTap	
	
	

SPARE PARTS

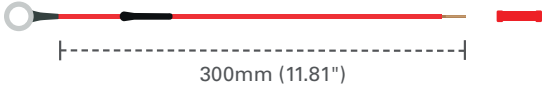
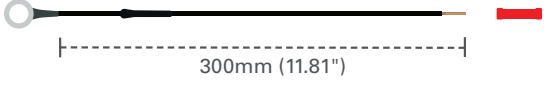
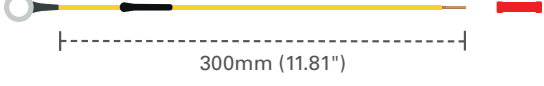
Spare Parts (cont.)

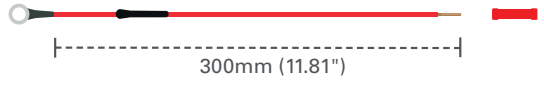
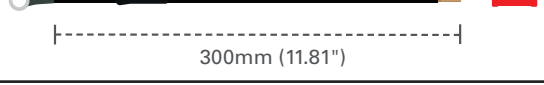
Terminal Connection B8 - Bolt	
Part no.	Parts
IQ-RFB8 Terminal Connection M8 Bolt	
	
	

Terminal Connection S - M4 Screw	
Part no.	Parts
IQ-RFS Terminal Connection M4 Screw	
	
	

iQ GATEway™ Battery Data Transmitter	
Part no.	Parts
IQ-GATE-CW10 Global 4G cellular gateway with Wifi support	

Notes

www.enersys.com

© 2024 EnerSys. All rights reserved. Unauthorised distribution prohibited.
Trademarks and logos are the property of EnerSys and its affiliates except
UL, CE, UKCA, IEC, Android, and iOS, which are not the property of EnerSys.
Subject to revisions without prior notice. E.&O.E.

GLOB-EN-OM-IQM-0924

