

CXPS-E3 400A Power System

ORDERING GUIDE



an EnerSys company



an EnerSys® company

CXPS-E3 Ordering Guide

- **Integrated -48V, 400A power system with front access distribution**
- **Industry leading power system density**
- **400A, 26 distribution positions in 5RU**
- **Advanced CXC-HP controller with touch screen display for full local control**
- **High temperature rated design for harsh outdoor applications**
- **Wide range AC input for flexible worldwide deployment**

Alpha’s E3 uses high-density rectifiers, a front access distribution center and the advanced CXC HP controller. The E3 is the ideal solution for small to medium-sized 48VDC applications, providing up to 400 Amps of output current. With universal 19/23" mounting, high temperature operation and high power density, it is the perfect solution for a wide variety of installation scenarios including those in harsh, outdoor environments. The distribution center provides up to 26 load breaker positions, integrated shunt and LVD. All distribution connections and controller I/O contacts are front accessible.

The CXC-HP controller includes a touch screen GUI for simple and convenient local setup. A built-in web server provides alternate setup via local or remote IP access, using a standard internet browser. The E3 can be easily integrated into customer-provided relay racks or enclosures, or can be ordered factory installed into various Alpha relay rack configurations, including systems with pre-wired battery trays.

Ordering Equipment

S.NO	PART NUMBER	SYSTEM DESCRIPTION
1	0919007-001	CXPS-E3, 23", 5RU, -48V, 400A, 2x 2.4kW Rectifier Shelf, CXC-HP, 26 Load Breakers
2	0919006-001	CXPS-E3, 23", 5RU, -48V, 400A, 2x 2.4kW Rectifier Shelf, CXC-HP, 21 Load Breakers, 5 Battery Breakers, e/w LVBD
3	0919007-002	CXPS-E3, 19", 5RU, -48V, 400A, 2x 2.4kW Rectifier Shelf, CXC-HP, 21 Load Breakers
4	0919006-002	CXPS-E3, 19", 5RU, -48V, 400A, 2x 2.4kW Rectifier Shelf, CXC-HP, 16 Load Breakers, 5 Battery Breakers, e/w LVBD
5	0919011-001	CXPS-E3 23", 7RU, -48V, 400A, 1x 4kW Rectifier Shelf, Single Phase, 26 Load Breakers
6	0919011-002	CXPS-E3 19", 7RU, -48V, 400A, 1x 4kW Rectifier Shelf, Single Phase, 21 Load Breakers
7	0919012-001	CXPS-E3 23", 7RU, -48V, 400A, 1x 4kW Rectifier Shelf, Single Phase, 21 Load Breakers, 5 Battery Breakers e/w LVBD
8	0919012-002	CXPS-E3 19", 7RU, -48V, 400A, 1x 4kW Rectifier Shelf, Single Phase, 16 Load Breakers, 5 Battery Breakers e/w LVBD



an EnerSys® company

Alpha Technologies Services, Inc. USA: 3767 Alpha Way, Bellingham, WA 98226 Canada: 7700 Riverfront Gate, Burnaby, BC V5J 5M4
 Toll Free North America: +1 800 322 5742 Outside US: +1 360 647 2360 Technical Support: +1 800 863 3364
 For more information visit www.alpha.com

© 2020 Alpha Technologies Services, Inc. All Rights Reserved. Trademarks and logos are the property of Alpha Technologies Services, Inc. and its affiliates unless otherwise noted. Subject to revisions without prior notice. E. & O.E.

09/2020
 #0470209-00 Rev H



an EnerSys® company

How to build an E3 Power System

Step 1: Pick Seismic Rack (Integrated in Systems)

PART NUMBER	SEISMIC RACK OPTION
0300163-001	23", 7'0" Height, 2500lb, Welded Seismic Rack
0300063-003	23", 3'6" Height, 500lb, Bolted Seismic Rack
0300047-001	23", 7'0" Height, 1500lb, Bolted Seismic Rack
0300047-002	23", 7'0" Height, 1000lb, Bolted Seismic Rack
0300047-003	23", 7'0" Height, 500lb, Bolted Seismic Rack
0300064-001	23", 7'6" Height, 1500lb, Bolted Seismic Rack
0300065-001	23", 8'0" Height, 1500lb, Bolted Seismic Rack
0300066-001	23", 9'0" Height, 1500lb, Bolted Seismic Rack
0300062-001	19", 7'0" Height, 1500lb, Bolted Seismic Rack
0300062-002	19", 7'0" Height, 1000lb, Bolted Seismic Rack
0300062-003	19", 7'0" Height, 500lb, Bolted Seismic Rack

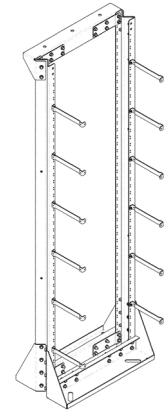

Step 2: Pick E3 Power System (Integrated in Systems)

PART NUMBER	POWER SYSTEM OPTION
0919007-001	CXPS-E3, 23", 5RU, -48V, 400A, 2x 2.4kW Rectifier Shelf, CXC-HP, 26 Load Breakers
0919006-001	CXPS-E3, 23", 5RU, -48V, 400A, 2x 2.4kW Rectifier Shelf, CXC-HP, 21 Load Breakers, 5 Battery Breakers, e/w LVBD
0250030-015	CXPS-E3, 19", 5RU, -48V, 400A, 2x 2.4kW Rectifier Shelf, CXC-HP, 21 Load Breakers
0250030-014	CXPS-E3, 19", 5RU, -48V, 400A, 2x 2.4kW Rectifier Shelf, CXC-HP, 16 Load Breakers, 5 Battery Breakers, e/w LVBD
0250029-001	CXPS-E3, 23", 7RU, -48V, 400A, 1x 4kW Rectifier Shelf, CXC-HP, 26 Load Breakers, 208-277Vac, 1P
0250029-002	CXPS-E3, 19", 7RU, -48V, 400A, 1x 4kW Rectifier Shelf, CXC-HP, 21 Load Breakers, 208-277Vac, 1P
0250029-003	CXPS-E3, 23", 7RU, -48V, 400A, 1x 4kW Rectifier Shelf, CXC-HP, 21 Load Breakers, 5 Battery Breakers, w/LVBD, 208-277Vac, 1P
0250029-004	CXPS-E3, 19", 7RU, -48V, 400A, 1x 4kW Rectifier Shelf, CXC-HP, 16 Load Breakers, 5 Battery Breakers, w/LVBD, 208-277Vac, 1P
0250029-005	CXPS-E3, 23", 7RU, -48V, 400A, 1x 4kW Rectifier Shelf, CXC-HP, 26 Load Breakers, 480/277Vac
0250029-006	CXPS-E3, 23", 7RU, -48V, 400A, 1x 4kW Rectifier Shelf, CXC-HP, 21 Load Breakers, 5 Battery Breakers, w/ LVBD, 480/277Vac
0250029-007	CXPS-E3, 23", 7RU, -48V, 400A, 1x 4kW Rectifier Shelf, CXC-HP, 26 Load Breakers, 208Vac
0250029-008	CXPS-E3, 23", 7RU, -48V, 400A, 1x 4kW Rectifier Shelf, CXC-HP, 21 Load Breakers, 5 Battery Breakers, w/LVBD, 208Vac



an EnerSys® company

Alpha Technologies Services, Inc. USA: 3767 Alpha Way, Bellingham, WA 98226 Canada: 7700 Riverfront Gate, Burnaby, BC V5J 5M4
 Toll Free North America: +1 800 322 5742 Outside US: +1 360 647 2360 Technical Support: +1 800 863 3364
 For more information visit www.alpha.com

© 2020 Alpha Technologies Services, Inc. All Rights Reserved. Trademarks and logos are the property of Alpha Technologies Services, Inc. and its affiliates unless otherwise noted. Subject to revisions without prior notice. E. & O.E.



an EnerSys® company

Step 3: Pick Battery Trays (Integrated in Systems)

PART NUMBER	SYSTEM INTEGRATION ITEMS
0300061-003 (0300061-503)	23", Seismic Battery Tray (23", Seismic Battery Tray, Field Service Kit)
0300077-002	19", Seismic Battery Tray
0380128-001 (0380128-501)	19/23", Breaker Housing Kit (19/23", Breaker Housing Kit, Field Service Kit)
0250030-550	Battery Cable Landing Bus Bar Kit

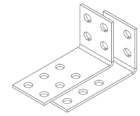
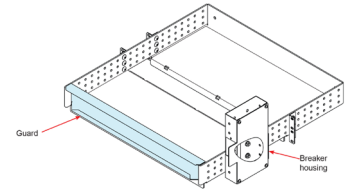

Step 4: Pick Battery Breakers (Integrated in Systems)

PART NUMBER	PLUG-IN BATTERY BREAKERS (INSTALLED INTO E3)
470-347-10	CB, 1P, 100A, 80VDC, 5/16" Bullet, Series-trip
4700153*	CB, 2P, 200A, 80VDC, 5/16" Bullet, Series-trip
4700235**	CB, 3P, 300A, 80VDC, 5/16" Bullet, Series-trip
470-346-10	CB, 1P, 60A, 80Vdc, 5/16" Bullet, Series-trip
4700187	CB, 1P, 125A, 80Vdc, 5/16" Bullet, Series-trip
470-673-19*	CB, 2P, 150A, 80Vdc, 5/16" Bullet, Series-trip
470-674-19**	CB, 3P, 250A, 80Vdc, 5/16" Bullet, Series-trip
PART NUMBER	PLUG-IN BATTERY BREAKERS (INSTALLED INTO BREAKER HOUSING KIT)
470-054-10	CB, 1P, 100A, 65VDC, 1/4-20 Bolt-In, Series-trip
470-228-10	CB, 1P, 250A, 125VDC, 7/16" Bolt-In, Series-Trip
4700229	CB, 1P, 125A, 80VDC, 1/4-20 Bolt-In, Series-trip
*2 Pole Breaker Adaptor Kit is required **3 Pole Breaker Adaptor Kit is required	
5230008	Jumper, 1P, 100A, 5/16" Bullet

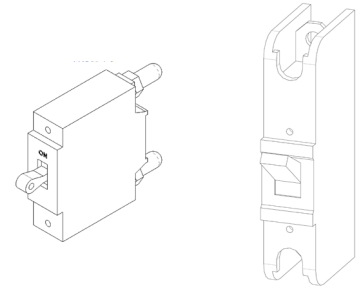

Step 5: Pick Mid-Point Monitoring System (Integrated in Systems)

PART NUMBER	SYSTEM INTEGRATION ITEMS
018-546-20-150	23", 1RU, SD08 BFDm Shelf, 4x Blank Modules
018-546-20-157	19", 1RU, SD08 BFDm Shelf, 3x Blank Modules
747-109-20-140	SD08 Mid-Point Battery Monitor Module

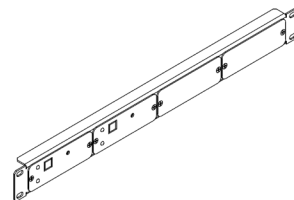

an EnerSys® company

Alpha Technologies Services, Inc. USA: 3767 Alpha Way, Bellingham, WA 98226 Canada: 7700 Riverfront Gate, Burnaby, BC V5J 5M4
 Toll Free North America: +1 800 322 5742 Outside US: +1 360 647 2360 Technical Support: +1 800 863 3364
 For more information visit www.alpha.com

© 2020 Alpha Technologies Services, Inc. All Rights Reserved. Trademarks and logos are the property of Alpha Technologies Services, Inc. and its affiliates unless otherwise noted. Subject to revisions without prior notice. E. & O.E.

09/2020
 #0470209-00 Rev H



an EnerSys® company

Step 6: Pick Temperature Probes (Integrated in Systems)

PART NUMBER	TEMPERATURE PROBES	PART NUMBER	TEMPERATURE PROBES
747-028-20-071	Temp Snsr, ¼" Lug, 6ft Cable Assy	747-082-20-071	Temp Snsr, ⅜" Lug, 6ft Cable, Assy
747-028-20-072	Temp Snsr, ¼" Lug, 12ft Cable Assy	747-082-20-072	Temp Snsr, ⅜" Lug, 12ft Cable, Assy
747-028-20-073	Temp Snsr, ¼" Lug, 24ft Cable Assy	747-082-20-073	Temp Snsr, ⅜" Lug, 24ft Cable, Assy
747-028-20-080	Temp Snsr, ¼" Lug, 50ft Cable Assy	747-082-20-080	Temp Snsr, ⅜" Lug, 50ft Cable, Assy
747-028-20-081	Temp Snsr, ¼" Lug, 100ft, Cable Assy	747-082-20-081	Temp Snsr, ⅜" Lug, 100ft Cable, Assy

NOTE: If battery trays are integrated into system, battery ring terminals shall follow temperature sensor size. If ⅜" lug is required choose PN: 5380225 in addition to temperature sensor.

Step 7: Pick Seismic Rack Accessories (Shipped Loose)

PART NUMBER	SEISMIC RACK ACCESSORIES
0380042-021	Seismic Anchor and Washer Kit
0380063-001	23", Bolted Seismic Rack Insulation Pad and Bushing Kit
0380108-001	19", Bolted Seismic Rack Insulation Pad and Bushing Kit
0380195-001	23", Welded Seismic Rack Insulation Pad and Bushing Kit

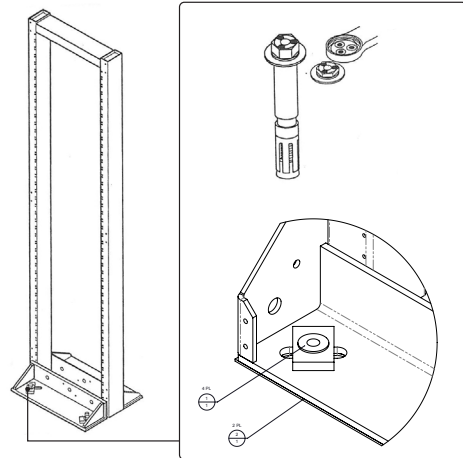

Step 8: Pick Rectifiers (Shipped Loose)

PART NUMBER	RECTIFIERS
0100003-001	48V, 2.4kW Rectifier
7400424-001	2.4kW Rectifier Blank
0100037-001	48V, 3.0kW Rectifier
010-623-20-040	48V, 4.0kW Rectifier
7400116-001	4.0kW Rectifier Blank

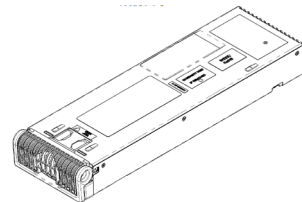

an EnerSys® company

Alpha Technologies Services, Inc. USA: 3767 Alpha Way, Bellingham, WA 98226 Canada: 7700 Riverfront Gate, Burnaby, BC V5J 5M4
 Toll Free North America: +1 800 322 5742 Outside US: +1 360 647 2360 Technical Support: +1 800 863 3364
 For more information visit www.alpha.com

© 2020 Alpha Technologies Services, Inc. All Rights Reserved. Trademarks and logos are the property of Alpha Technologies Services, Inc. and its affiliates unless otherwise noted. Subject to revisions without prior notice. E. & O.E.

09/2020
 #0470209-00 Rev H



an EnerSys® company

Step 9: Pick Load Breakers (Shipped Loose)

PART NUMBER	LOAD BREAKERS
470-300-10	CB, 1P, 1A, 80VDC, 5/16" Bullet, Mid-trip
470-301-10	CB, 1P, 3A, 80VDC, 5/16" Bullet, Mid-trip
470-302-10	CB, 1P, 5A, 80VDC, 5/16" Bullet, Mid-trip
470-303-10	CB, 1P, 10A, 80VDC, 5/16" Bullet, Mid-trip
470-304-10	CB, 1P, 15A, 80VDC, 5/16" Bullet, Mid-trip
470-305-10	CB, 1P, 20A, 80VDC, 5/16" Bullet, Mid-trip
470-306-10	CB, 1P, 25A, 80VDC, 5/16" Bullet, Mid-trip
470-307-10	CB, 1P, 30A, 80VDC, 5/16" Bullet, Mid-trip
470-308-10	CB, 1P, 35A, 80VDC, 5/16" Bullet, Mid-trip
470-309-10	CB, 1P, 40A, 80VDC, 5/16" Bullet, Mid-trip
470-310-10	CB, 1P, 45A, 80VDC, 5/16" Bullet, Mid-trip
470-311-10	CB, 1P, 50A, 80VDC, 5/16" Bullet, Mid-trip
470-312-10	CB, 1P, 60A, 80VDC, 5/16" Bullet, Mid-trip
470-313-10	CB, 1P, 70A, 80VDC, 5/16" Bullet, Mid-trip
470-314-10	CB, 1P, 80A, 80VDC, 5/16" Bullet, Mid-trip
470-315-10	CB, 1P, 90A, 80VDC, 5/16" Bullet, Mid-trip
470-316-10	CB, 1P, 100A, 80VDC, 5/16" Bullet, Mid-trip
470-317-10*	CB, 2P, 110A, 80VDC, 5/16" Bullet, Mid-trip
470-318-10*	CB, 2P, 125A, 80VDC, 5/16" Bullet, Mid-trip
470-319-10*	CB, 2P, 150A, 80VDC, 5/16" Bullet, Mid-trip
4700234*	CB, 2P, 175A, 80VDC, 5/16" Bullet, Mid-trip
4700154*	CB, 2P, 200A, 80VDC, 5/16" Bullet, Mid-trip
470-357-10**	CB, 3P, 225A, 80VDC, 5/16" Bullet, Mid-trip
470-342-10**	CB, 3P, 250A, 80VDC, 5/16" Bullet, Mid-trip
4700149**	CB, 3P, 300A, 80VDC, 5/16" Bullet, Mid-trip
4700279	CB, 1P, 70A, 80VDC, 5/16" Bullet, Mid-trip (Inverter 2000)

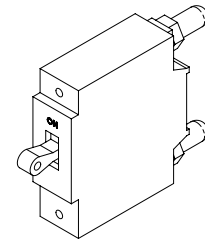

Load Breaker 1P

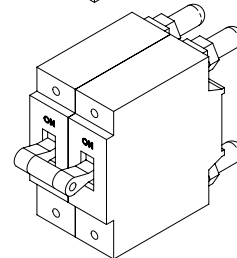

Load Breaker 2P

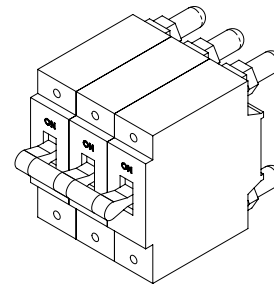

Load Breaker 3P

*2 Pole Breaker Adaptor Kit is required **3 Pole Breaker Adaptor Kit is required



an EnerSys® company

Alpha Technologies Services, Inc. USA: 3767 Alpha Way, Bellingham, WA 98226 Canada: 7700 Riverfront Gate, Burnaby, BC V5J 5M4
 Toll Free North America: +1 800 322 5742 Outside US: +1 360 647 2360 Technical Support: +1 800 863 3364
 For more information visit www.alpha.com

© 2020 Alpha Technologies Services, Inc. All Rights Reserved. Trademarks and logos are the property of Alpha Technologies Services, Inc. and its affiliates unless otherwise noted. Subject to revisions without prior notice. E. & O.E.

09/2020
 #0470209-00 Rev H



an EnerSys® company

Step 10: Pick Breaker Adaptor Kit

PART NUMBER	BREAKER ADAPTOR KIT
0370298-001	CXDM-E2/E3, 2 Pole Breaker Adaptor Kit
0370299-001	CXDM-E2/E3, 3 Pole Breaker Adaptor Kit

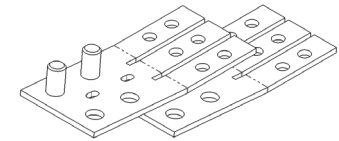
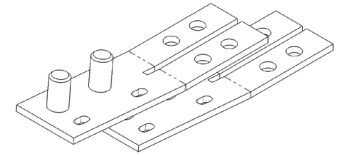

Step 11: Pick TPS Fuses (Shipped Loose)

PART NUMBER	TPS FUSES
460-217-10	TPS/TLS Fuse, 5A, 170VDC
460-218-10	TPS/TLS Fuse, 6A, 170VDC
460-219-10	TPS/TLS Fuse, 10A, 170VDC
460-220-10	TPS/TLS Fuse, 15A, 170VDC
460-221-10	TPS/TLS Fuse, 20A, 170VDC
460-222-10	TPS/TLS Fuse, 25A, 170VDC
460-223-10	TPS/TLS Fuse, 30A, 170VDC
460-224-10	TPS/TLS Fuse, 40A, 170VDC
460-225-10	TPS/TLS Fuse, 50A, 170VDC
460-226-10	TPS/TLS Fuse, 60A, 170VDC
460-227-10	TPS/TLS Fuse, 70A, 170VDC
460-229-10	TPS/TLS Fuse, 90A, 170VDC
460-230-10	TPS/TLS Fuse, 100A, 170VDC
4600056	TPS/TLS Fuse, 110A, 170VDC
4600057	TPS/TLS Fuse, 125A, 170VDC
520-059-10	TFD Fuse Holder

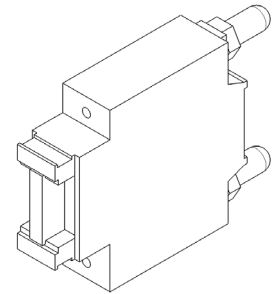

an EnerSys® company

Alpha Technologies Services, Inc. USA: 3767 Alpha Way, Bellingham, WA 98226 Canada: 7700 Riverfront Gate, Burnaby, BC V5J 5M4
Toll Free North America: +1 800 322 5742 Outside US: +1 360 647 2360 Technical Support: +1 800 863 3364
For more information visit www.alpha.com

© 2020 Alpha Technologies Services, Inc. All Rights Reserved. Trademarks and logos are the property of Alpha Technologies Services, Inc. and its affiliates unless otherwise noted. Subject to revisions without prior notice. E. & O.E.