



AlphaCell HP

Users Guide

AlphaCell HP Battery
Effective: July 2011



Power

Alpha Technologies 

Power

AlphaCell™ HP Battery Users Guide

Storage, Maintenance and Deployment

745-680-C5-001, Rev. A

Effective Date: July, 2011
Copyright © 2011
Alpha Technologies, Inc.

member of The  Group™

-  **NOTE:**

Photographs contained in this manual are for illustrative purposes only. These photographs may not match your installation.
-  **NOTE:**

Operator is cautioned to review the drawings and illustrations contained in this manual before proceeding. If there are questions regarding the safe operation of this powering system, please contact Alpha Technologies or your nearest Alpha representative.
-  **NOTE:**

Alpha shall not be held liable for any damage or injury involving its enclosures, power supplies, generators, batteries or other hardware if used or operated in any manner or subject to any condition not consistent with its intended purpose or is installed or operated in an unapproved manner or improperly maintained.

Contacting Alpha Technologies: *www.alpha.com*

or

For general USA sales information and customer service (7 AM to 5 PM, Pacific Time), call

1 800 863 3930

For complete technical support in the USA, call
7 AM to 5 PM, Pacific Time or 24/7 emergency support

1 800 863 3364

For Sales information and Technical Support in Canada, call

1 800 667 8743

Table of Contents

Safety Notes	6
Battery Maintenance Guidelines.....	7
Recycling and Disposal Instructions.....	7
Important Storage Practices	8
Electrical Safety.....	8
Chemical and Mechanical Safety	9
1.0 Introduction.....	10
1.1 Description.....	11
1.2 Operating Conditions.....	12
1.3 Capacity.....	12
1.3.1 Ratings	13
2.0 Preparing for Maintenance	14
2.1 Required Tools and Equipment	14
3.0 Periodic Maintenance Tasks and Schedule.....	15
3.1 Monthly Remote Status Monitoring	15
3.2 Quarterly Preventive Maintenance	16
3.3 AlphaCell™ Battery Maintenance Log	18
3.4 Battery Evaluation Procedures	20
3.5 Battery Refurbishment Plan.....	21
4.0 Battery System Float Charging.....	22
4.1 Alpha Power Supply Charging Profile	23
5.0 Troubleshooting.....	24
6.0 Battery Parameters by Model Number	27
7.0 Warranty and Return Information	28
7.1 AlphaCell™ Limited Warranty.....	28
7.2 Battery Maintenance Report for Return Authorizations	30

Figures and Tables

Fig. 1, Capacity vs Storage Time.....	8
Fig. 2, Series Connected String of Batteries	11
Fig. 3, Parallel String of Batteries	11
Fig. 4, Available Capacity vs. Ambient Temperature	12
Fig. 5, Flow Chart, Monthly Status Monitoring.....	15
Fig. 6, Flow Chart, Quarterly Preventive Maintenance.....	16
Fig. 7 Flow Chart for Battery Refurbishment Plan.....	21
Fig. 8, Charger Modes.....	23
Table 1, Conductance values, new vs. suspect batteries	20
Table 2, Troubleshooting	24
Table 3, Battery Parameters, Current Models	27
Table 4, Warranty Periods for AlphaCell™ batteries	28

Safety Notes

Review the drawings and illustrations contained in this manual before proceeding. If there are any questions regarding the safe installation or operation of the system, contact Alpha Technologies or the nearest Alpha representative. Save this document for future reference.

To reduce the risk of injury or death, and to ensure the continued safe operation of this product, the following symbols have been placed throughout this manual. Where these symbols appear, use extra care and attention.

ATTENTION:

The use of ATTENTION indicates specific regulatory/code requirements that may affect the placement of equipment and installation procedures.



NOTE:

A NOTE provides additional information to help complete a specific task or procedure.



CAUTION!

The use of CAUTION indicates safety information intended to PREVENT DAMAGE to material or equipment.



WARNING!

A WARNING presents safety information to PREVENT INJURY OR DEATH to the technician or user.



WARNING!

Lead-acid batteries contain dangerous voltages, currents, and corrosive material. Battery installation, maintenance, service, and replacement must only be performed by authorized personnel.

Battery Maintenance Guidelines

- For optimal performance, inspect batteries every 6 months for:
 - **Signs of battery cracking, leaking or swelling.** The battery should be replaced immediately by authorized personnel using a battery of the identical type and rating (**match conductance, voltages, and date codes as specified in this document**).
 - **Signs of battery cable damage.** Battery cable should be replaced immediately by authorized personnel using replacement parts specified by vendor.
 - **Loose battery connection hardware.** Refer to documentation for the correct torque and connection hardware for the application.
- Do not attempt to remove the vents (valves) from the AlphaCell HP battery or add water. This is a safety hazard and voids the warranty.
- Apply NO-OX grease on all exposed connections.
- When necessary, clean up any spilled electrolyte in accordance with all federal, state, and local regulations or codes.
- Follow approved storage instructions.
- Always replace batteries with those of an identical type and rating. Never install untested batteries.
- Do not charge batteries in a sealed container. Each individual battery should have at least 1/2 inch of space between it and all surrounding surfaces to allow for convection cooling.
- All battery compartments must have adequate ventilation to prevent an accumulation of potentially dangerous gas. **Never place batteries in a sealed enclosure.** Extreme caution should be used when maintaining and collecting data on the battery system.

Recycling and Disposal Instructions

- Spent or damaged batteries are considered environmentally unsafe as they contain lead and dilute sulfuric acid. They should not be "thrown away" with common refuse.
- Always recycle used batteries in accordance with federal, state, provincial, and local regulations. The Alpha Group provides recycling services. Call 800 863 3930 or contact your local Alpha representative.

Important Storage Practices

During storage please note:

- All lead acid batteries experience self-discharge while in open circuit storage. This causes circuit voltage and capacity to decrease.
- The self-discharge rate is related to ambient temperature. The lower the temperature, the less the discharge. Batteries should be stored in a clean, ventilated, and dry location with an ambient temperature of 32°F to 77°F (0°C to 25°C).
- It is important to track open circuit voltage which is related to the density of the electrolyte. If the open circuit voltage is lower than 12.6V or the batteries have been stored beyond the limits shown in Figure 1, the batteries should be charged to avoid damage caused by self-discharge.
- All batteries should be fully charged before storage. Record the storage date and next supplemental charge date in a maintenance record and on the battery.
- Upon battery deployment, verify all batteries within each string measure in the range of +/- 0.3Vdc of the string average.



NOTE:

The product warranty is void if the batteries are not stored and recharged in accordance with these guidelines.

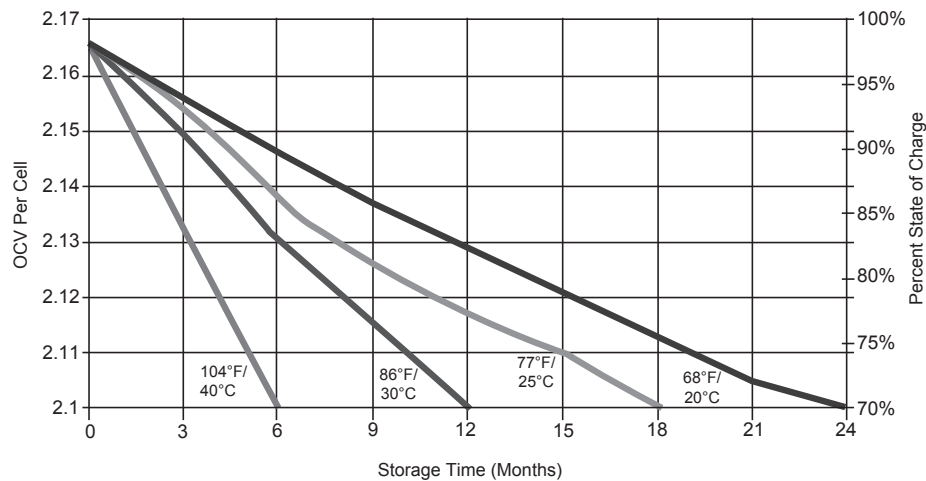

Fig. 1, Capacity vs. Storage Time

Electrical Safety

- Lethal voltages are present within the power supply and electrical enclosures. Never assume that an electrical connection or conductor is not energized. Check circuits with a volt meter prior to any installation or removal procedure.
- Observe circuit polarities.
- Always use the buddy system when working under hazardous conditions.
- Ensure no liquids or wet clothes contact internal components.
- Hazardous electrically live parts inside this unit are energized from batteries even when the AC input power is disconnected.
- Use an insulated blanket to cover exposed portions of the battery system when performing extended maintenance that could result in personal or equipment contact with the energized conductors.
- Certain types of rectifier circuits used in charging the battery may not include a line isolating transformer. In these cases extreme caution should be used when maintaining and collecting data on the battery system.



WARNING!

Chemical Hazards

Any liquid emissions from a valve-regulated lead-acid (VRLA) battery contains dilute sulfuric acid, which is harmful to the skin and eyes. Emissions are electrolytic and are electrically conductive and corrosive.

To avoid injury:

- Servicing and connection of batteries shall be performed by, or under the direct supervision of, personnel knowledgeable of batteries and the required safety precautions.
- Always wear eye protection, rubber gloves, and a protective vest when working near batteries. To avoid battery contact, remove all metallic objects, (such as rings or watches), from your person.
- Batteries produce explosive gases. Keep all open flames and sparks away from batteries.
- Use tools with insulated handles, do not rest any tools on top of batteries.
- Batteries contain or emit chemicals known to the State of California to cause cancer and birth defects or other reproductive harm. Battery post terminals and related accessories contain lead and lead compounds. Wash hands after handling (California Proposition 65).
- If any battery emission contacts the skin, wash immediately and thoroughly with water. Follow your company's approved chemical exposure procedures.
- Neutralize any spilled battery emission with the special solution contained in an approved spill kit or with a solution of one pound (454g) bicarbonate of soda to one gallon (3.8l) of water. Report a chemical spill using your company's spill reporting structure and seek medical attention if necessary.
- Always replace batteries with those of an identical type and rating (***match conductance, voltages, and date codes as specified in this document***).
- Never install old or untested batteries.
- Prior to handling the batteries, touch a grounded metal object to dissipate any static charge that may have developed on your body.
- Use special caution when connecting or adjusting battery cabling. An improperly or unconnected battery cable can make contact with an unintended surface that can result in arcing, fire, or a possible explosion.
- A battery showing signs of cracking, leaking, or swelling should be replaced immediately by authorized personnel using a battery of identical type and rating.

Mechanical Safety

- Keep hands and tools clear of fans.
- Fans are thermostatically controlled and will turn on automatically.
- Power supplies can reach extreme temperatures under load.
- Use caution around sheet metal components, especially sharp edges.
- Depending on the model, batteries can weigh anywhere from 25 to 100 pounds (11kg to 45kg). Exercise care when handling and moving batteries. Use proper handling equipment.

1.0 Introduction

The purpose of this guide is to provide the user with the necessary information to maintain batteries in storage and deploy batteries in Alpha Powering systems, as well as perform battery testing, install replacements and recycling.

This manual guides you through periodic maintenance checks and troubleshooting of the AlphaCell HP Thin Plate Pure Lead AGM battery.

Adherence to the procedures and practices detailed in this guide will not only insure the battery operates per specifications, but also provides the proper backup for the Alpha Powering system in which it is installed.

To achieve these goals, this guide will address the following topics:

- The storage and maintenance of new battery inventory.
- Deployment of AlphaCell HP batteries into Alpha Power systems.
- Proper preventative maintenance practices for AlphaCell HP batteries.
- Replacement and recycling of AlphaCell HP batteries.
- Warehousing, testing, and redeployment of reuseable AlphaCell HP batteries.
- How to keep proper maintenance records for troubleshooting and/or Warranty claims.

1.1 Description

The AlphaCell HP battery is a lead acid battery that facilitates an oxygen recombination cycle.

A 12V battery is made up of six 2V cells internally connected to provide 12 volts.

The battery system is a group of 12V batteries connected in a series string to provide a higher voltage system. In Fig. 2, three of the nominal 12V batteries are connected in series to provide an 18 cell system with a nominal voltage of 36V.

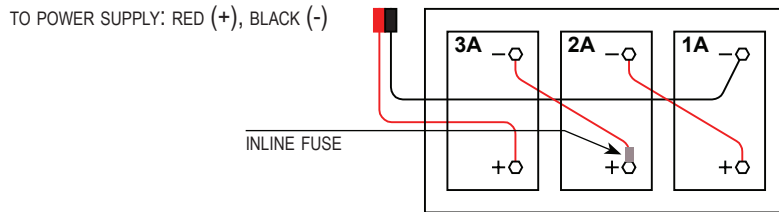

Fig. 2, Series String of Batteries
(For illustration purposes, a 36Volt string is shown. 48Volt strings are also available)

You can connect multiple strings of batteries in parallel. This provides a system whose capacity equals the sum capacity of all the strings. For example, in Fig. 3, two 36V 90Ah capacity strings are connected in parallel to provide a nominal 36V at 180Ah.



WARNING!

Alpha highly recommends fusing in single and parallel string configurations.

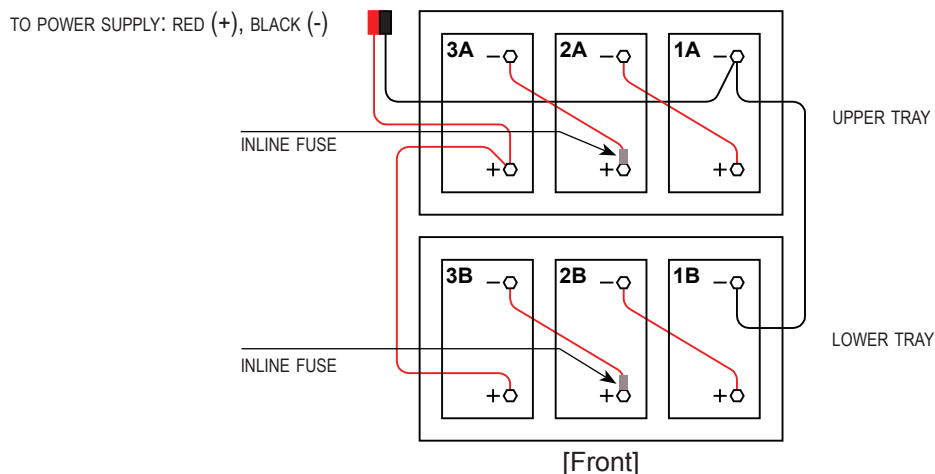

Fig. 3, Parallel String of Batteries

1.0 Introduction, continued

1.2 Operating Conditions

AlphaCell HP batteries, which are valve regulated and virtually sealed, do not give off perceptible amounts of gas under normal operating conditions.

- Acceptable ambient operating temperature: -40°F to 131°F (-40°C to 55°C)
- Ideal ambient operating temperature: 68°F to 77°F (20°C to 25°C)
- Ambient humidity: ≤ 95%

1.3 Capacity

The actual capacity is related to the utilization ratio of the active positive and negative materials within the battery. The utilization ratio is influenced by the depth of discharge, the structure of the battery, and the manufacturing technology. During normal usage, the factors that influence the actual capacity are discharge rate, depth of discharge, end voltage, and temperature.

- The higher the discharge rate, the lower the available capacity.
- As batteries get colder, the available capacity is reduced. This is related to the kinetics of the electrochemical reactions and the resistivity of the electrolyte (See Fig. 4).

 **NOTE:** Although the battery can be operated at temperatures below -4°F (-20°C), the capacity and ability to discharge will be dramatically decreased. Similarly, temperatures approaching 122°F (50°C) will increase electrolyte loss and corrosion of the plates, resulting in a shorter battery life.

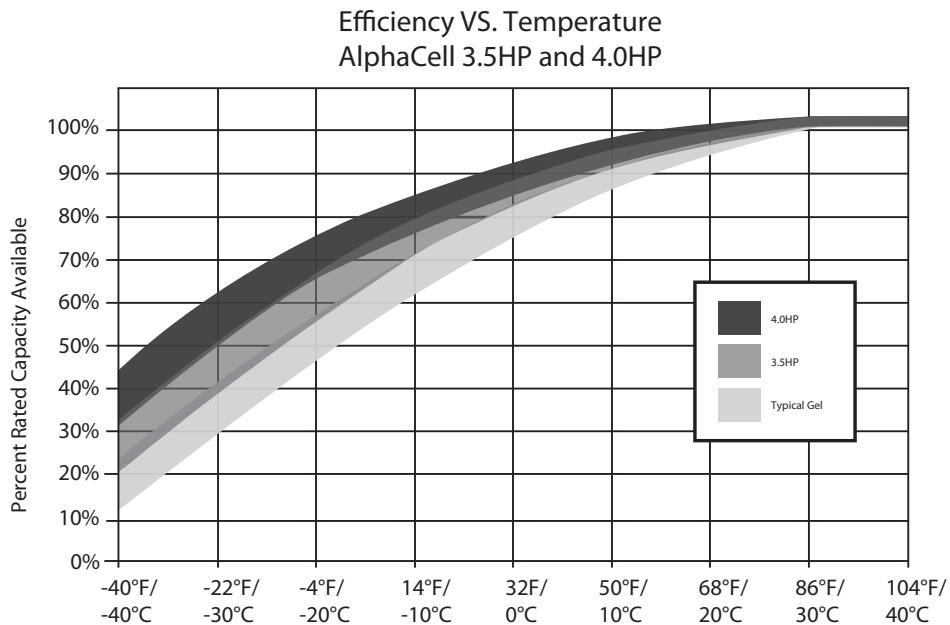

Fig. 4, Available Capacity vs. Ambient Temperature

1.0 Introduction, continued

1.3 Capacity, continued

1.3.1 Ratings

3.5 HP Ratings

Amps											
End Voltage	15min	30min	45min	1hr	2hr	3hr	4hr	5hr	8hr	10hr	20hr
1.85	162.6	106.4	80.5	65.3	38	27.1	21.2	17.4	11.4	9.3	4.9
1.80	174.7	112.1	84.2	67.9	39.2	27.9	21.8	17.9	11.8	9.6	5.1
1.75	185.6	117.2	87.3	70.2	40.3	28.6	22.3	18.4	12.1	9.9	5.2
1.70	194.9	121.3	89.9	72	41.1	29.2	22.7	18.7	12.3	10	5.3

Power (Watts)											
End Voltage	15min	30min	45min	1hr	2hr	3hr	4hr	5hr	8hr	10hr	20hr
1.85	312.2	206	156.9	127.9	75.4	54.2	42.5	35.1	23.1	18.9	9.9
1.80	331	215.4	163.1	132.4	77.5	55.5	43.5	35.9	23.7	19.4	10.2
1.75	347.6	223.6	168.3	136.2	79.2	56.7	44.4	36.6	24.2	19.8	10.5
1.70	361.7	230.3	172.6	139.2	80.6	57.5	45	37.1	24.5	20.1	10.7

A/H Capacity											
End Voltage	15min	30min	45min	1hr	2hr	3hr	4hr	5hr	8hr	10hr	20hr
1.85	40.7	53.2	60.4	65.3	75.9	81.3	84.7	87.1	91.5	93.4	98.6
1.80	43.7	56.1	63.1	67.9	78.5	83.8	87.2	89.7	94.3	96.2	101.7
1.75	46.4	58.6	65.5	70.2	80.6	85.9	89.3	91.8	96.5	98.6	104.4
1.70	48.7	60.7	67.4	72	82.2	87.5	91	93.5	98.3	100.4	106.6

4.0 HP Ratings

Amps											
End Voltage	15min	30min	45min	1hr	2hr	3hr	4hr	5hr	8hr	10hr	20hr
1.85	198.7	128.3	95.9	77	43.7	30.8	24	19.4	12.5	10.1	5.4
1.80	212.8	134.6	99.7	79.7	44.9	31.6	24.5	19.8	12.8	10.4	5.6
1.75	225.2	139.9	102.9	81.9	45.9	32.2	25	20.2	13.1	10.6	5.7
1.70	235.7	144.3	105.5	83.7	46.7	32.8	25.4	20.5	13.3	10.8	5.8

Power (Watts)											
End Voltage	15min	30min	45min	1hr	2hr	3hr	4hr	5hr	8hr	10hr	20hr
1.85	383.9	251.6	189.4	152.7	87.5	61.9	48.2	39	25.3	20.5	11
1.80	406.8	261.8	195.7	157.2	89.6	63.3	49.3	39.9	25.9	21	11.3
1.75	426.7	270.5	200.9	160.9	91.3	64.5	50.1	40.6	26.4	21.3	11.5
1.70	443.1	277.4	205.1	163.8	92.6	65.4	50.8	41.2	26.7	21.6	11.6

A/H Capacity											
End Voltage	15min	30min	45min	1hr	2hr	3hr	4hr	5hr	8hr	10hr	20hr
1.85	49.7	64.2	72	77	87.5	92.5	95.8	96.9	100.3	101.3	108.8
1.80	53.2	67.3	74.8	79.7	89.8	94.8	98.1	99.2	102.7	103.8	111.7
1.75	56.3	70	77.2	81.9	91.8	96.7	100	101.1	104.7	105.9	114
1.70	58.9	72.1	79.1	83.7	93.3	98.2	101.5	102.6	106.3	107.5	115.8

2.0 Preparing for Maintenance

The battery system should be remotely monitored monthly and physically inspected quarterly. If the battery system has an automatic monitoring system to gather the electrical and environmental data, the monthly checks should consist of evaluating the recorded data and visiting any site that does not meet the specifications listed in the detailed procedures below. At a minimum each site needs to be physically inspected every three months.

You do not have to measure the electrolyte specific gravity or add water to the cells.

All batteries in the string should be numbered to facilitate recording and analysis of data unique to each unit.

Notify anyone affected by the intended maintenance or troubleshooting activity. This should include but not be limited to anyone responsible for the status monitoring equipment at the head-end or NOC.

2.1 Required Tools and Equipment

Prior to beginning maintenance, ensure that all required tools and equipment, including safety equipment, is available and functional.

The following is a list of the minimum equipment required to maintain and troubleshoot the AlphaCell HP battery:

- Digital voltmeter
- Socket wrenches, insulated
- Box end wrenches, insulated
- Torque wrench calibrated in inch/lbs
- Rubber gloves
- Full face shield
- Safety Glasses
- Plastic apron
- Portable eyewash
- Spill kit, including sodium bicarbonate solution
- Fire extinguisher
- Optional equipment, depending on the type of maintenance being performed, includes:
 - True RMS Volt Meter with DC Amp Clamp
 - Midtronics Conductance Meter
 - 100 amp momentary load test set
 - System load bank (DC if to be performed at the battery and AC if to be performed by loading a power supply output— contact your Alpha Sales Representative for purchasing information).
 - NO-OX Corrosion Inhibitor
 - Paper Towels and/or rags

3.0 Periodic Maintenance Tasks and Schedule

The following tasks are to be performed on a monthly and quarterly schedule.

The following maintenance procedure requires a fully functional status monitoring system capable of remotely measuring and recording the following data on a periodic basis:

- Battery Temperature
- Individual Battery Voltage
- Total Battery String Voltage

Please note: If status monitoring is not available these checks need to be made during the quarterly onsite visit and any batteries not meeting the minimum requirement must be addressed at such time.

3.1 Monthly Remote Status Monitoring

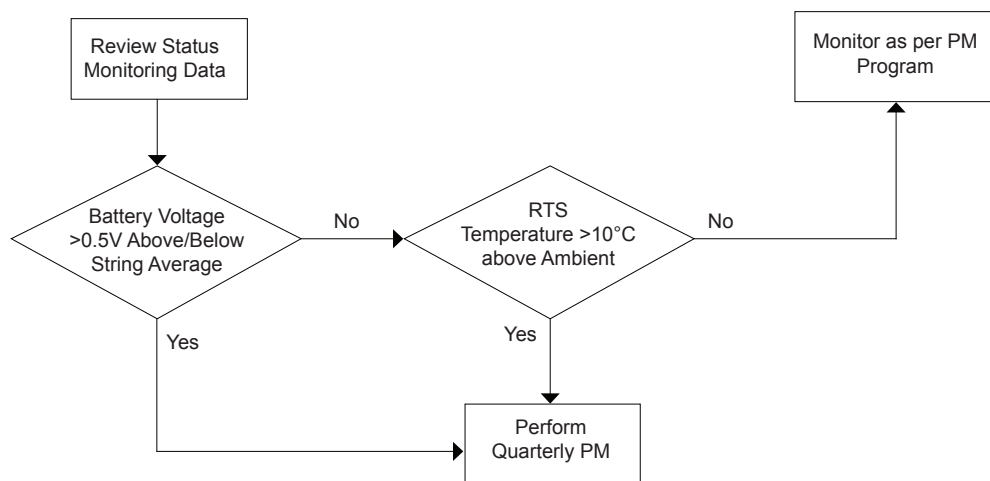

Fig. 5, Flow Chart for Monthly Remote Status Monitoring

Procedure

1. If any individual battery voltage varies more than 0.5V above or below the average for the string then a site visit is required.
Example $V1 = 13V, V2 = 13V, V3=14V$
Average voltage = 13.3V
If $V3$ greater than average by 0.5V, then a site visit is required
2. If the RTS temperature is greater than 10 degrees C above the current regional ambient temperature then a site visit is required.
3. Prioritize site visits based on highest RTS temperatures and battery voltages
4. Visit the site within 30 days and remedy the problem by replacing the bad battery or batteries and reset quarterly maintenance.

3.2 Quarterly Preventive Maintenance

Required Equipment

- True RMS Volt Meter with DC Amp Clamp
- Midtronics Conductance Battery Tester

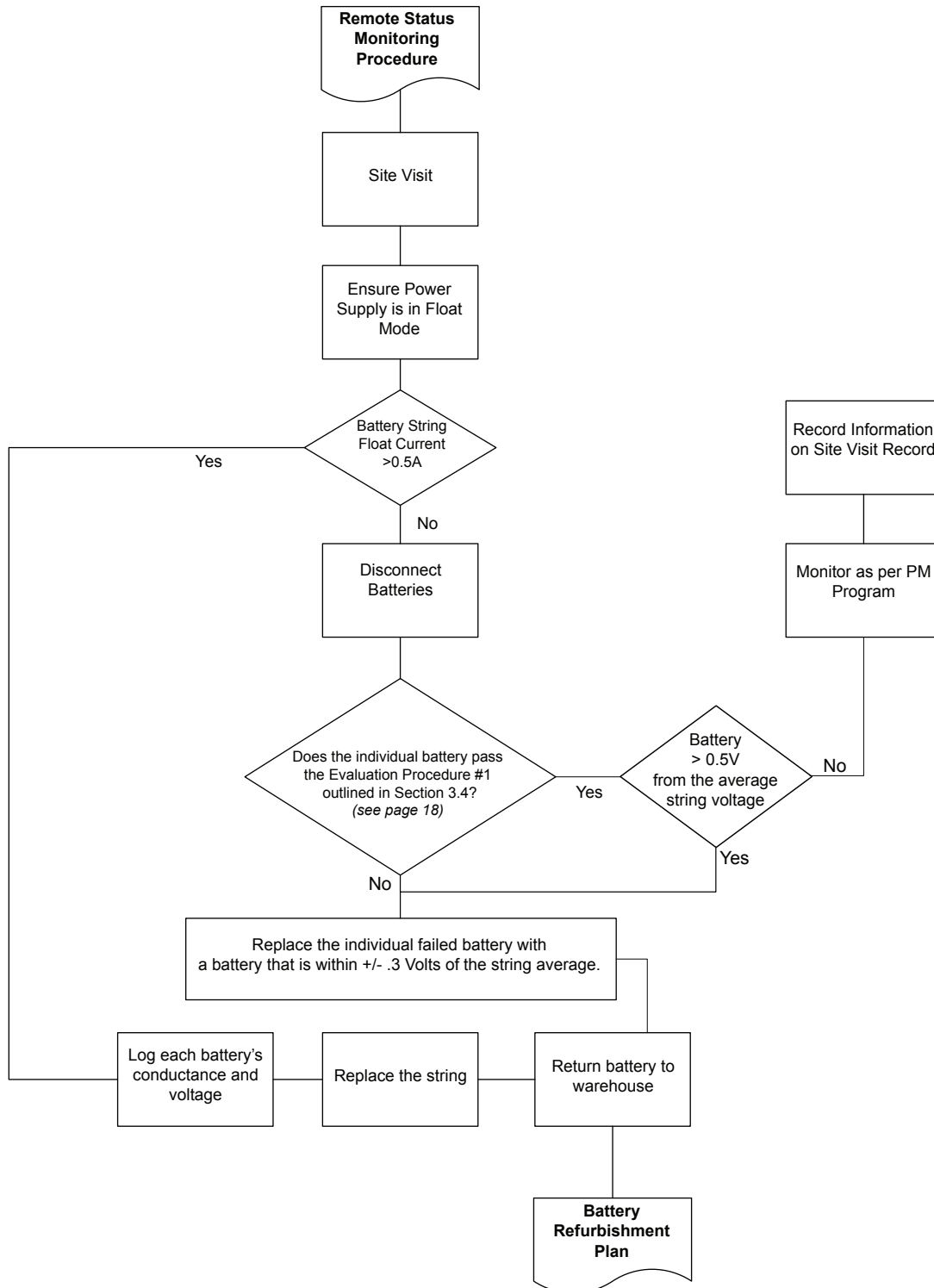

Fig. 6, Flow Chart for Quarterly Preventive Maintenance

3.2 Quarterly Preventive Maintenance, continued

Procedure

1. Verify the power supply is in Float mode.
2. Use the DC Amp clamp to measure and record each individual battery string's float current.
3. If the individual string float current is greater than 0.5 amps, replace the battery string. Measure and record the individual battery conductance and voltage on the Site Visit Record.
4. If the string float current is less than 0.5 amps,
 - 4.1 Disconnect the batteries from the system
 - 4.2 Measure the battery conductance. If any reading is below the suspect level, refer to Table 1, page 20, for mhos values for battery models.
 - 4.3 Measure the battery voltage. If any reading is less than 12.6V then replace all those batteries in the string.
 - 4.4 If any individual battery voltage varies more than 0.5V above or below the average for the string then replace the string.

Example: V1 = 13V, V2 = 13V, V3=14V
Average voltage = 13.3V
If V3 is greater than average by 0.5V, then the batteries should be replaced.
Batteries removed from the site should then be tested per Section 3.5,
"Battery Refurbishment Plan".
 - 4.5 Log the site location, battery location, model, manufacturer date codes, voltage and conductance readings for all batteries.
5. Record data on Battery Maintenance log.
6. Verify the spacing between the batteries from front to back is at least 1/2" or 13mm, and adjacent batteries do not touch one another.
7. Ensure the enclosure is clean and free of debris.
8. Measure and record the top center battery's temperature. This is typically the warmest battery in the string.
9. Visually inspect the batteries for:
 - Cleanliness
 - Terminal damage or evidence of heating or overheating
 - Container or cover damage
10. Check terminal posts for signs of corrosion. If corrosion is present, neutralize with a solution of 1 lb (454g) sodium bicarbonate (baking soda) to 1 gallon (3.8l) of water. Rinse and dry.
11. Verify terminal posts are coated with NO-OX grease or a spray-on protectant. Reapply as needed.
12. Retorque all the interunit connecting hardware to the values noted in Table 3 on page 27.

3.4 Battery Evaluation procedures for AlphaCell™ HP

To help identify batteries approaching end of life in an operating power system, test #1 should be performed at each maintenance interval. For batteries not installed in an operating power system, test #2 or #3 may be performed. For accuracy, tests must be performed on fully charged batteries.

A battery failing any of the following combined tests is defined as a faulty battery. The battery will be replaced under the terms of the warranty if within the defined warranty period.

Evaluation Procedure 1

Conductance/Impedance Test – Measure the conductance of each battery. Any battery that possesses a conductance that is 50% less than the initial reading taken at the point of install can be considered suspect of being below 70% capacity and should be evaluated further. The battery temperature must be approximately the same each time this reading is taken (see Table 1 below). Use temperature compensation feature when using Midtronics meter.

AND

Float Voltage Test – Measure the float voltage of each battery in the string that is on float charge. Any battery in the string measured at 13.2 volts or less is a suspect battery and should be further evaluated with the steps below. Any battery below 12.6 volts should be replaced. The 13.2 & 12.6 voltage values are based on a 77°F (25°C) temperature. Adjust the voltage for higher or lower temperatures by 0.0168 Volts per battery per degree Fahrenheit. The higher the temperature above 77° F (25°C) the lower the voltage will have to be adjusted and vice-versa for temperature below 77°F (25°C). (i.e.: at a temp of 89°F (32°C) would have a corresponding float voltage of 13.0 volts).

Evaluation Procedure 2

Conductance/Impedance Test – Measure the conductance of each battery. Any battery that possesses a conductance that is 50% less than the initial reading taken at the point of install can be considered suspect of being below 70% capacity and should be evaluated further. The battery temperature must be approximately the same each time this reading is taken. Consult table 1 below for guidance. Use temperature compensation feature when using Midtronics meter.

AND

24 Hour Open Circuit Test – Measure the open circuit voltage of the suspected battery 24 hours after the battery has come off of float charge. Care must be taken to ensure that the battery is at full state of charge when it is disconnected from the power supply. The battery should exhibit a voltage about 12.60V. A battery below this voltage should be replaced. A fully charged battery below 12.6 volts is below 70% capacity, but a battery above 12.6 volts is not necessarily above 70% in capacity. Batteries that have been sitting for extended periods should be recharged after 6 months or when they reach 12.48 volts (75% capacity), which ever comes first depending on the storage temperature.

Evaluation Procedure 3

24 Hour Open Circuit Test – Measure the open circuit voltage of the suspected battery 24 hours after the battery has come off of float charge. Care must be taken to ensure that the battery is at full state of charge when it is disconnected from the power supply. The battery should exhibit a voltage about 12.60 volts. A battery below this voltage should be replaced. A fully charged battery below 12.6 volts is below 70% capacity, but a battery above 12.6 volts is not necessarily above 80% in capacity. Batteries that have been sitting for extended periods should be recharged after 6 months or when they reach 12.48 volts (75% capacity), which ever comes first depending on the storage temperature.

AND

100A Load Test – Measure the voltage of each battery at the end of a 10 second 100-amp load test. Again, the temperature must be equivalent to that of the original test performed at the point of installation. A significant drop in voltage versus the previous test will indicate deterioration of the battery. A 12-volt battery that falls below 10.80 volts should be considered faulty and should be replaced.

 **NOTE:**

To maintain consistent test results, ensure the same Midtronics conductance tester is used for each test cycle.

Midtronics Conductance Models 3200/micro CELLTRON	3.5 HP	4.0 HP
Approximate Conductance Values (mhos) Healthy Battery @ 77°F (25°C)	1400-1850	1700-2500
Suspect Battery @ 77°F (25°C) in mhos	<680	<840

Table 1, Conductance values, healthy vs. suspect batteries

3.5 Battery Refurbishment Plan

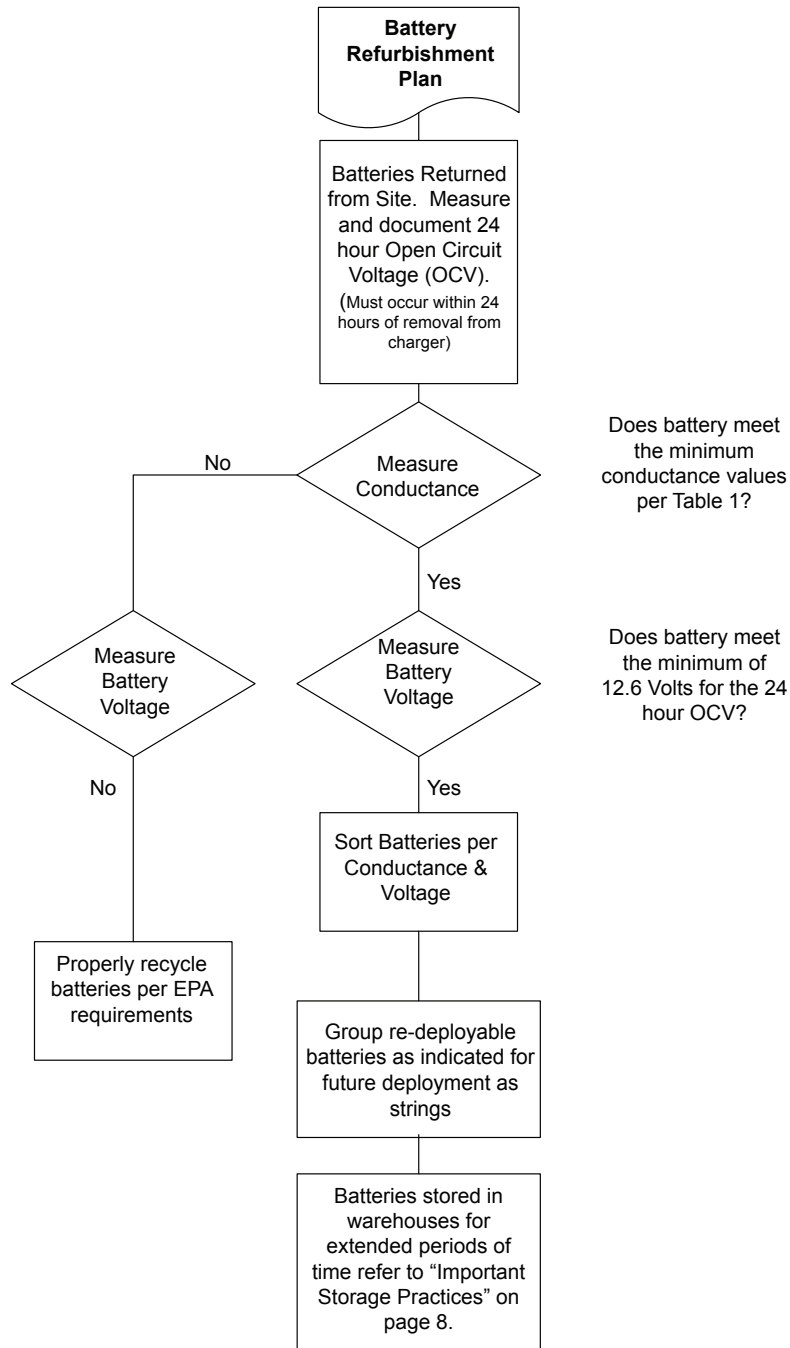

Fig. 7, Flow Chart for Battery Refurbishment Plan

4.0 Battery System Float Charging

Battery System Float Charging Voltage

Encountering temperature extremes

When you encounter temperature extremes, temperature compensate the float charging voltage. The temperature compensation coefficient is $-0.0022 \text{ V/C per } ^\circ\text{F}$ ($-0.004 \text{ V/C per } ^\circ\text{C}$).

For example if the normal battery temperature is 90°F (13° above 77°F) you should reduce the average float charging voltage range by 0.028 V/C ($13^\circ \times -0.0022 \text{ V/C per } ^\circ\text{F}$) to between 2.21 and 2.26 V/C .

If the battery operates at cold temperatures, (60°F , 17° below 77°F , for example), you can increase the charging voltage to improve recharging time.

For example, increase the charging voltage range by $-17^\circ \times -0.0022 \text{ V/C per degree}$ or 0.037 V/C .

Under or overcharging

If the battery is undercharged for a period of time during which there are multiple discharges, the battery does not fully recharge after each discharge and provides progressively lower capacity.

Excessive overcharging causes premature aging of the battery and loss of capacity, noted by excessive float current, corrosion of the plate grids, and gassing and drying of the limited amount of electrolyte.

Severe overcharging over extended periods of time can induce a thermal runaway condition. This requires replacing the battery system.



NOTE:

The following set points are recommended for AlphaCell HP Batteries when used with the XM Series 2 or GMX Power Supply.

AlphaCell™ HP Batteries	
Accept	2.35 V/C
Float	2.25 V/C
Temp Comp	-4mV/C/C

4.0 Battery System Float Charging, continued



NOTE:

The following information specifically pertains to Alpha XM Series 2 and HP Power Supplies.

4.1 Alpha Power Supply Charging Profile

BULK charge is a “Constant Current” charge. This current is the maximum the charger is capable of delivering: 10A for 615, 906/915/915HV, and 922/922HV. As the charge is returned to the batteries, their voltage increases to a specific threshold (2.27Vdc per cell). The BULK charger mode generally returns the battery charge state to 80 percent of rated battery capacity. Bulk mode is not temperature compensated. The charger then automatically switches to ACCEPT mode.

ACCEPT charge is a “Constant Voltage” charge. This voltage, 2.2-2.45Vdc per cell, is manually adjustable if needed and temperature-compensated to ensure longer battery life and proper completion of the charge cycle.

This cycle is complete when the charging current into the batteries becomes less than 0.5A, or approximately six hours elapses from the time ACCEPT mode was entered. When the batteries are fully recharged the charger switches to the FLOAT mode of operation.

FLOAT charge is a temperature-compensated charge, averaging about 2.1-2.35Vdc (adjustable) per cell. During FLOAT mode, the batteries are fully charged and ready to provide backup power.

During ACCEPT and FLOAT modes, the cell voltage is temperature-compensated at -0.004Vdc per cell per degree C (adjustable) to ensure a safe battery cell voltage and to maximize battery life.

For AlphaCell HP batteries, the recommended battery system float charge voltage is equal to the number of cells in the system multiplied by the range of 2.1 to 2.35 volts per cell at $77^\circ\text{F}(25^\circ\text{C})$.

For example, float charge a string of 3 each 12 volt (6 cell) batteries within a range of 37.8 to 42.3 Vdc ($18\text{ cells} \times 2.1\text{ V/C}$ minimum and $18 \times 2.35\text{ V/C}$ maximum) at $77^\circ\text{F}(25^\circ\text{C})$.

Severe overcharging over extended periods of time can induce a thermal runaway condition. This requires replacing the battery system.

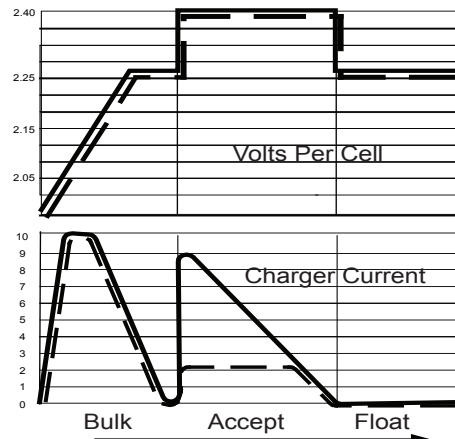

Fig. 8, Charger Modes (dashed line indicates HV models)

5.0 Troubleshooting

Problem with	Symptom	Possible Causes	Possible Result	Corrective Actions
Capacity Test Results	Reduced operating time at 77°F (25°C) with smooth voltage decline	Normal life cycle	Eventual failure to support the load followed by potential for shorted cells	Replace battery system when at 70% of rated capacity or before
	Reduced operating time at 77°F (25°C) with steep voltage decline or voltage plateaus	Individual low capacity cells	Reversed cells during discharge Reversed cells will become very hot and will not fully recharge	Replace the isolated low capacity batteries
	Excessive initial voltage drop even to the point of dropping load in the first several seconds	<ul style="list-style-type: none"> Battery is extremely cold Cabling is too small gauge High resistance connections Battery is undersized Shorted cells 	<ul style="list-style-type: none"> Excessive voltage drop Cells will become hot, could develop thermal runaway; internal arcing could result in an explosion 	<ul style="list-style-type: none"> Heat the battery Run parallel cables or increase gauge of cables Clean and reassemble connections Add required parallel strings Replace isolated units with shorts and evaluate entire string
Visual Battery Checks	Cover or container crack	Handling or impact damage	Cell dryout or ground fault. Potential internal gas ignition	Replace damaged unit.
	Cover or container explosion	Ignition of cell internal gasses due to external source, fusing, or internal conductive path or internal spark due to shorting. Potential exists for ill-maintained batteries or those left in service beyond useful life.	<ul style="list-style-type: none"> Personal injury and equipment damage at time of explosion. Failure to support load. 	Replace damaged unit and evaluate balance of string.
	Burned area on container	Crack in container wicking electrolyte to grounded rack. Ground fault	Could result in <ul style="list-style-type: none"> personal hazard due to conductive path to rack smoke or battery fire thermal runaway 	Clear the ground fault and replace defective unit. Evaluate balance of string.
	Permanently deformed (swollen) container	Thermal runaway possible caused by high temp., environment, overcharging, excessively high recharge current, shorted cells, ground fault, or a combination	Could result in the emission of hydrogen sulfide, detectable as a rotten egg odor, battery fire, and inability to support the load	Replace the battery system and correct the items leading to the thermal runaway condition
	Rotten egg odor	Possible caused by high temperature environment, overcharging, excessively high recharge current, shorted cells, ground fault, or a combination of these.	Odor is a product of thermal runaway	Replace the battery system and correct items leading to thermal runaway condition
	Melted grease at terminals	Hot connections due to excessive resistance caused by loose connections, dirty contact surfaces or corrosion within connection	<ul style="list-style-type: none"> Excessive voltage drop perhaps leading to short operating time or damaged terminals In extreme case could lead to melted terminal and ignition of the battery cover 	<ul style="list-style-type: none"> Clean and reassemble connection if damaged Replace batteries with damaged terminals
	Corrosion at terminals	Possibly electrolyte leaking from battery terminal seal attacking the interunit container	Increased connection resistance and resulting increase in the connection heating and voltage drop at high rate discharge.	Disassemble connection, clean, coat connecting surfaces and terminal area, seal with anti-oxidation grease, reassemble the connection. If leakage about terminal area is obvious, the battery should be replaced.

Table 2, Troubleshooting

5.0 Troubleshooting, continued

<i>Problem with</i>	<i>Symptom</i>	<i>Possible Causes</i>	<i>Possible Result</i>	<i>Corrective Actions</i>
DC Voltage Checks	System float voltage > 2.3V/C average 77°F (25°C)	Charger output set incorrectly	Overcharging causes excessive gassing and drying out of electrolyte and contributes to potential thermal runaway.	Reset the charger output voltage to recommended value.
	System float voltage < 2.25V/C average 77°F (25°C)	Charger output set incorrectly	Undercharging results in gradual loss of operating time and capacity with successive discharge cycles. If persistent, an irreversible level of lead sulfate develops on the plates resulting in a permanent capacity loss	<ul style="list-style-type: none"> Reset the charger output voltage to recommended value. Equalize battery system from 48 to 72 hours and perform capacity test. If capacity loss is permanent, replace the total battery system.
	Individual battery float voltage > 13.3 Vdc	<ul style="list-style-type: none"> Potentially the individual battery has shorted cell Verify with impedance or conductance check 	Reduced operating time under load. Increased float current. Heating of cell during discharge. Contributes to potential thermal runaway.	Replace individual battery.
	Individual battery float voltage 14.5 Vdc for 6 cell	Potentially open cells in individual battery. Confirm by checking for zero float current or check for very high impedance of the battery.	Failure to support load. Could result in an internal arc, could ignite gasses within the cell.	Replace individual battery.
	DC voltage measured between battery system output terminals and ground (rack) or a ground fault indicated by automatic monitoring equipment.	Damaged container allowing electrolyte to wick out to grounded surface (rack).	<ul style="list-style-type: none"> Personnel shock hazard resulting in serious injury or electrocution. Potential burning of container at damaged area or battery fire. 	Determine the source of ground fault and replace battery.
Temperature Checks	Elevated room temperature	Lack of adequate air conditioning or ventilation	Reduced battery life	Cool room or accept reduced battery life
	Elevated battery temp.	<ul style="list-style-type: none"> Elevated room temp. Inadequate cabinet ventilation Discharge - charge cycle 	<ul style="list-style-type: none"> Reduced battery life Reduced life and potential thermal runaway Normal if not exceeding 18°F increase 	<ul style="list-style-type: none"> Improve room air conditioning Improve cabinet ventilation Limit recharge current
	High current recharge	<ul style="list-style-type: none"> High charging voltage Shorted cells 	Normal if not exceeding 18F/10C increase over ambient	<ul style="list-style-type: none"> Limit recharge current Reduce within specifications Replace shorted cells and evaluate total string.

Table 2, Troubleshooting, continued

5.0 Troubleshooting, continued

Type	Symptom	Possible Causes	Possible Result	Corrective Action
Float Charging Current Checks	Float current to string is zero	A battery or connection in series string is open. Verify via the float voltage check or AC ripple voltage or impedance check of individual batteries.	<ul style="list-style-type: none"> Failure to support load. If an internal arc occurs during discharge, can ignite gasses internal to cell. If there is an open/loose connection in external conductive path, can damage termination under load. 	Replace battery with open cell or repair open/loose external connection.
	Float current exceeds 3.0 milliamperes per ampere hour of rated capacity at 77°F(25°C) at float voltage.	<ul style="list-style-type: none"> Batteries not fully recharged. Batteries above 77°F(25°C) Potentially shorted cells in battery Depending on degree, battery entering or in thermal runaway 	<ul style="list-style-type: none"> Not at 100% capacity Conducive to thermal runaway Thermal runaway results in eventual meltdown of battery and potential of hydrogen sulfide emissions and fire. 	Determine specific cause; take corrective action.
High Rate 10 Second Load Test	Terminal voltage marginally below minimum voltage specified for 10 second point.	Battery perhaps not fully charged or is older, in service battery and has somewhat lower capacity.	Perhaps reduced operating time.	Fully recharge battery.
	Terminal voltage significantly below minimum voltage specified for 10 second point.	<ul style="list-style-type: none"> Battery discharged of battery conductive path, plate grid, or active material or electrolyte volume deterioration. Shorted. Open cells. 	<ul style="list-style-type: none"> Reduced operating time. Conducive to thermal runaway Will not support load 	Charge, retest battery or replace as required.
Battery Impedance/Conductance Test	Impedance / resistance increase by 50% from original values or conductance decline to 50% of the value when new.	<ul style="list-style-type: none"> Battery discharged or battery conductive path, plate grid or active material, or electrolyte volume deterioration. Shorted cells Open cells 	<ul style="list-style-type: none"> Reduced operating time Conducive to thermal runaway Will not support load 	Charge and retest battery or replace as required.
Connection Hardware Resistance / Tightness Check	Connection resistance increase 20% or more from original value.	<ul style="list-style-type: none"> Repetitive cycles results in heating and cooling of connection, resulting in relaxation of torque, increase in connection resistance. Contamination within the connection results in corrosion and high terminal resistance. 	<ul style="list-style-type: none"> Loose connections result in heat damaged or melted terminals during high rate discharge. Excessive voltage drop during high rate discharge and resulting reduced operating time 	<ul style="list-style-type: none"> Retorque connection as required Correct source of contamination, clean contact surface areas, grease contact surfaces with anti-oxidant grease, reassemble.
	Connection hardware tightness is less than the specified "retorque" value.	Repetitive cycles results in heating and cooling of connection resulting in relaxation of torque and increase in connection resistance.	Loose connections result in heat damaged or melted terminals during high rate discharge	Retorque the connection as required
AC Ripple Voltage Checks	AC ripple (p-p) voltage on system <4% of the value of the DC float voltage	Poor filtering of charger output.	Excessive AC ripple could cause the battery to cycle at the ripple frequency and result in heating and deterioration of the plate active material	Improve the charger output filtering.
	Individual battery in string exhibits AC ripple voltage twice that of other typical batteries in string.	Battery with high AC ripple voltage has proportionately higher impedance. Evaluate for performance. Subject battery could have deteriorating conductive path or dry, shorted or open cell.	<ul style="list-style-type: none"> Reduced operating time. Potential conditions could be conducive to thermal runaway. 	Verify battery condition. Replace as required.

Table 2, Troubleshooting, continued

6.0 Battery Parameters by Model Number

Parameter	Model Number	
	3.5 HP	4.0 HP
Terminal Type	Threaded Insert	Threaded Insert
Bolt Size	1/4"-20 UNC Bolt	1/4"-20 UNC Bolt
Annual Retorque Inch-Pounds / N•m	110In-lb / 2.4N•m	110In-lb / 2.4N•m
Open Circuit Voltage	12.80	12.80
Average Float Voltage Range (volts/unit)	12.6 to 14.1	12.6 to 14.1
Typical Impedance @ 60Hz ohms	2.7	2.2
Typical Conductance 7Hz mohms	1400 to 1850	1700 to 2500

Table 3, Battery Parameters, Current Models

7.0 Warranty and Return Information

7.1 AlphaCell HP Limited Warranty

Float Service Outdoor VRLA Batteries

This limited warranty applies only to the original purchaser (“User”) of the Product supplied under the Supply Agreement. A Battery will be considered defective, and can be replaced, when it fails to deliver 70% of its rated capacity during stated warranty period provided that it has been used in accordance with the conditions listed below. Standard Warranty periods are outlined in Table 4.

When a defective battery is identified the User should promptly notify manufacturer. Should manufacturer confirm the Batteries to be defective they will replace the material found to be defective F.O.B. its Factory without charge except for freight.

CONDITIONS AND LIMITATIONS: (all claims are subject)

- 1) Warranty date is based on Ship Date code stamped on battery.
- 2) Warranty applies in accordance with Table 4 of this section.
- 3) The standard warranty shown in Table 4 applies to AlphaCell HP Batteries used in Alpha enclosures in conjunction with Alpha Power Supplies.
- 4) A baseline Two Year Warranty applies to AlphaCell HP Batteries used in other applications not defined in item #3 shown above. AlphaCell HP batteries are not recommended for solar applications so please consult Alpha Applications Engineering for an alternative battery solution for solar applications. Extended warranties beyond two years may be available for unique enclosure/charger applications based on preapproval by Alpha Engineering. Consult your salesperson for details.
- 5) Each Battery must be of proper size, design and capacity for its application in order for the warranty to apply.
- 6) Each Battery must be charged, discharged, stored and serviced in accordance with the AlphaCell HP owners manual and user's guide.
- 7) Warranty is void if Battery is subject to misuse, abuse or physical damage or if Battery becomes unserviceable due to fire, wreckage, freezing, or any act of God.
- 8) Battery must be used with a temperature compensation charger having characteristic charging curves (voltage and current) acceptable with standard manufacturer's charging practices as outlined in the AlphaCell HP owners manual and user's guide.
- 9) User agrees that manufacturer's representative shall have access to equipment furnished hereunder for purpose of inspection at reasonable hours and intervals in order for the warranty to apply.
- 10) All defective and replacement Batteries, if returned, become property of manufacturer.
- 11) Field Batteries replaced through limited warranty terms and conditions will receive the balance of original warranty.
- 12) Standard AlphaCell HP Warranty requires a minimum semiannual preventive maintenance schedule with records as outlined in the AlphaCell HP owners manual and user's guide.

CLAIMS:

- 1) Contact original point of purchase for instructions on applicable warranty claim procedures.
- 2) Upon satisfactory proof of claim as determined by manufacturer, manufacturer shall repair or replace, at its option, any defective Battery based upon the purchase price, exclusive of freight and labor.
- 3) Manufacturer does not accept any product for return, credit or exchange unless expressly authorized by manufacturer in writing and returned prepaid to its plant.

ALPHA SHALL NOT BE LIABLE FOR, AND USER SHALL INDEMNIFY AND SAVE ALPHA HARMLESS FROM ANY CLAIMS AND LIABILITIES ARISING OUT OF THE USE, MAINTENANCE, TRANSPORTATION, OR INSTALLATION OF ANY EQUIPMENT WARRANTED HEREUNDER. THE FOREGOING LIMITED WARRANTY IS IN LIEU OF ALL WARRANTIES EXPRESSED OR IMPLIED, INCLUDING ANY WARRANTY OF MERCHANTABILITY OR FITNESS FOR A PARTICULAR PURPOSE. THE SOLE LIABILITY OF IS SET FORTH UNDER THE CLAIMS PARAGRAPH ABOVE. SHALL NOT HAVE ANY LIABILITY FOR ANY SPECIAL INCIDENTAL INDIRECT OR CONSEQUENTIAL DAMAGES. THIS LIMITED WARRANTY APPLIES ONLY TO THE ORIGINAL PURCHASER (USER) OF THE EQUIPMENT, AND IS NON-TRANSFERABLE.

7.1 AlphaCell HP Standard Limited Warranty, continued

The table below indicates the warranty periods for AlphaCell HP Batteries used with Alpha approved power supplies and enclosures.

Battery Model	Description	Warranty (US/Canada)	Warranty (International)
3.5 HP	Pure Lead	5 Years	4 Years
4.0 HP	Pure Lead	5 Years	4 Years

Table 4, Warranty periods for AlphaCell HP batteries

7.2 Battery Maintenance Report for Return Authorizations

Contact your Alpha Customer Service representative for assistance in processing your AlphaCell HP warranty claim.

Alpha Customer Service (800) 421-8089, or fax# (360) 671-4936

This form, in conjunction with Alpha's Battery Evaluation Procedure is intended as a method of collecting data critical to the efficient processing of your warranty battery claims. Record battery float voltage while the battery is still connected to the system. Record battery open circuit voltage (OCV) 24 hours following removal from the system. Describe the problem encountered with the battery as compared to the remaining batteries in the battery string. The ZRE# will be provided after you submit your request to Alpha for processing.

Original Purchase Order (if available) _____
 Company Name _____
 Address _____
 CSZ _____
 Contact Name _____
 Phone _____
 Email address _____
 Replacement Units Address _____
 CSZ _____
 Contact Name _____
 Phone _____
 Email address _____

Initial Install Date	Mfr. Date Code	PM History	Float Current	Battery Temperature	Evaluation Procedure #1		Evaluation Procedure #2		Evaluation Procedure #3	
					Vdc Float No Load	Conductance mhos @ 77°F	Vdc 24 Hour OCV	Conductance mhos @ 77°F	Vdc @ 100A after 10 seconds	Conductance mhos @ 77°F

**Alpha Technologies Inc.**

3767 Alpha Way
Bellingham, WA 98226
United States
Tel: +1 360 647 2360
Fax: +1 360 671 4936

Alpha Energy

1628 W Williams Drive
Phoenix, AZ 85027
United States
Tel: +1 602 997 1007
Fax: +1 623 249 7833

Alpha Technologies Europe Ltd.

Twyford House Thorley
Bishop's Stortford
Hertfordshire, CM22 7PA
United Kingdom
Tel: +44 1279 501110
Fax: +44 1279 659870

Alpha Technologies

Suite 1903, 19/F., Tower 1
33 Canton Road, Tsim Sha Tsui
China Hong Kong City, Kowloon
Hong Kong
Phone: +852 2736 8663
Fax: +852 2199 7988

Alpha Technologies Ltd.

7700 Riverfront Gate
Burnaby, BC V5J 5M4
Canada
Tel: +1 604 436 5900
Fax: +1 604 436 1233
Toll Free: +1 800 667 8743

Alpha Technologies GmbH

Hansastraße 8
D-91126
Schwabach, Germany
Tel: +49 9122 79889 0
Fax: +49 9122 79889 21

Alphatec Ltd.

339 St. Andrews St.
Suite 101 Andrea Chambers
P.O. Box 56468
3307 Limassol, Cyprus
Tel: +357 25 375 675
Fax: +357 25 359 595

Alpha Innovations Brasil

Avenida Ibirapuera,
2120 – Cj 76
Moema - 04028-001
Santos SP, Brazil
Tel: +55 11 2476 0150
Fax: +55 11 2476 0150

Alpha Industrial Power Inc.

1075 Satellite Blvd NW,
Suite 400
Suwanee, GA 30024
United States
Tel: +1 678 475 3995
Fax: +1 678 584 9259

Technologies Argus

First de Mexico
Anatole France Num. 17
Colonia Polanco
11560, México D.F.
Tel: +52 55 5280 6990

Alpha TEK ooo

Khokhlovskiy Pereulok 16
Stroenie 1, Office 403
Moscow, 109028
Russia
Tel: +7 495 916 1854
Fax: +7 495 916 1349

Alphatec Baltic

S. Konarskio Street 49-201
Vilnius, LT-03123
Lithuania
Tel: +370 5 210 5291
Fax: +370 5 210 5292

Visit us at www.alpha.com

Power