

  
CHARGING  
SOLUTIONS

# **NexSys<sup>®</sup>** **AIR**

WIRELESS CHARGER



# OWNER'S MANUAL

**EnerSys<sup>®</sup>**  
Power/Full Solutions



[www.enersys.com](http://www.enersys.com)

# CONTENTS

Features .....	3
Technical Information .....	3
Disclaimer.....	7
Safety Instructions .....	8
Protective Measures .....	11
Mechanical Installation .....	12
Operating Instructions .....	14
Settings Menu Information .....	18
Service and Troubleshooting .....	21

# FEATURES

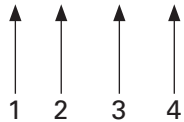
## Features

- The NexSys® Air series of wireless chargers is available in 7 & 10kW range of DC power up to 250A DC output.
- The NexSys® Air series of wireless chargers are compatible with 24, 36, 48, and 80 volt batteries.
- Omnidirectional approach for side mounting with high positioning tolerance.
- No synchronization between charger and vehicles to safely initiate charge; just align the pads to allow the charge to start.
- No synchronization between charger and vehicles to safely interrupt the charge; simply drive further apart from the pads to allow the charge to stop.
- No moving mechanical parts are needed in the vehicle, just a simple alignment of the pads to allow the charge to start.
- Once the pad is aligned, it takes a few seconds to start the charge, and usually less than 5 seconds to reach full power.
- No sparking.
- No wear and tear, and no part maintenance.
- Large 7" LCD touch screen display.
- Color LED for charge status.
- NexSys® Air wireless chargers are UNIX-based with microprocessor controller.
- Fully programmable via touch screen display or mobile app.
- Data communication transfer between pads via inductive transmission, with no risk for EMC or noise generated outside the pads.
- Unique patented profile for charging Thin Plate Pure Lead (TPPL) batteries.
- Unique profiles for NexSys® charging applications (NXBLOC; NXSTND; NXFAST).
- Fully integrated with NexSys® ION batteries.
- CAN integration to AGV ready via lithium CID.
- CAN integration to AGV ready via TPPL & flooded batteries via Wi-iQ® battery monitoring device.
- Integration to AGV overarching architecture via Ethernet MODBUSTCP/IP.
- Remote access via mobile app to change settings, monitor charger, and share data.

## Technical Information

**Main nameplates:** There is a nameplate label located on the outside of every single component of the charger. The model is required in any discussion or correspondence regarding this unit.

**WP3-10-480**



- 1) WP : Wireless Primary
- 2) 3 : Phase, 1 or 3
- 3) 10 : Primary, kW size
- 4) Input voltage: 400/480V

### Primary Unit Identification Label

Type : WIRELESS BATTERY CHARGER  
 Model : WP3-10-480  
 Serial Number : WBYD001254  
 FCC ID: VPYLBE5HY1MW  
 IC: 772C-LBEE5HY1MW

Complies with  
 UL 1564  
 CSA C22.2 No. 107.2

3ØVac : 400/480 V ± 10 % 50/60 Hz

	WS-07XX	WS-10XX
400 V	12 A	17 A
480 V	10 A	14 A

### Address Labels

For Sales and Service call 800  
 EnerSys  
 761 Eastern Bypass  
 Richmond, KY 40475

North America

EnerSys  
 Rue Alexander Fleming  
 ZI Est  
 62033 Arras, France

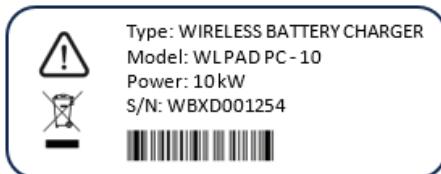
Other Regions

# TECHNICAL INFORMATION

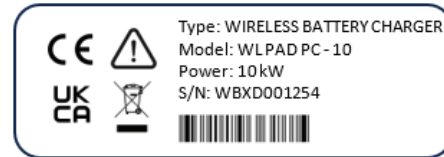
## Technical Information (cont.)

Item	Description
Model No	Identifies the Type of Wireless Component (PC = Primary converter, PAD PC = PAD Primary Converter, PAD SC = PAD Secondary Converter, SC = Secondary Converter) and the Rated Power.
Reference No	Identified product design drawings.
Serial Number	Unique serial number of the part.
Hertz	AC input voltage frequency. <b>Under no conditions operate the charger at a different frequency or from a generator with unstable frequency.</b>
Phase	Number "3" indicates a Three Phase Charger and "1" indicates a Single Phase Charger.
AC Volts	Nominal voltage for which this primary converter is rated to operate.
Max AC Amps	Maximum AC amps for which primary converter is rated.
FCC ID	US Federal ID for wireless communication.
IC	CA ID for wireless communication.
CE	Logo is applied to chargers that are certified with the CE certification in accordance with European Economic Area regulations.
UKCA	UK Conformity Assessed mark to indicate that it conforms to GB legislation.
MET	The MET mark indicates the product is tested and certified by MET, a nationally recognized testing laboratory by OSHA for the US and Canadian safety standards indicated on the label.
Model No	MET-recognized number that indicates the ratings of the charger at full capacity.

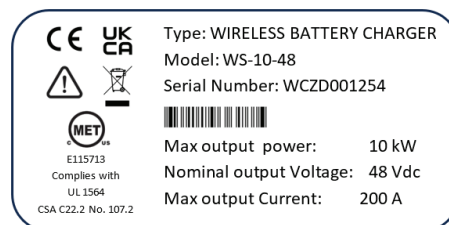
Primary Pad Label



Secondary Pad Label



Secondary Converter Identification Label



# TECHNICAL INFORMATION

## Technical Information (cont.)

### Secondary Converter Current and Voltage Table

Model	WL SC-24-7	WL SC-36-10	WL SC-48-10	WL SC-80-10
Reference	GL0008275-0001	GL0008275-0002	GL0008275-0003	GL0008275-0004
Nominal Output Voltage (V)	24	36	48	80
Max Output Power (kW)	7	10	10	10
Max Output Current (A)	250	250	200	120

### Charge Profile Letter Code

Charging Profile	Description
<b>STDWL</b>	Flooded profile for Hawker® Water Less® batteries EMEA.
<b>NXBLOC</b>	Designed for NexSys® TPPL bloc batteries at 0.2 to 0.7 C6 charging rates.
<b>NXSTND</b>	Designed for NexSys® 2V batteries at 0.2 to 0.25 C6 charging rates.
<b>NXFAST</b>	Designed for NexSys® 2V batteries at 0.26 to 0.40 C6 charging rates.
<b>VRLA</b>	IEIE (constant current, constant voltage, constant current, constant voltage) profile type for Valve Regulated Lead Acid (VRLA) batteries.
<b>LITHIUM</b>	Designed for NexSys® ION batteries.

### Equalization Charging (Lead-Acid Products)

Equalization charging, performed after normal charging; balances the electrolyte densities in the battery's cells.

Equalization charging can be set on the Wi-iQ® battery monitoring device, which will trigger the wireless charger accordingly.

### Refresh Charging (Lead-Acid Products)

Refresh or maintenance charging enables the charger to maintain the battery at a maximum state of charge if secondary pad is maintained aligned to the primary pad after the charge is complete.

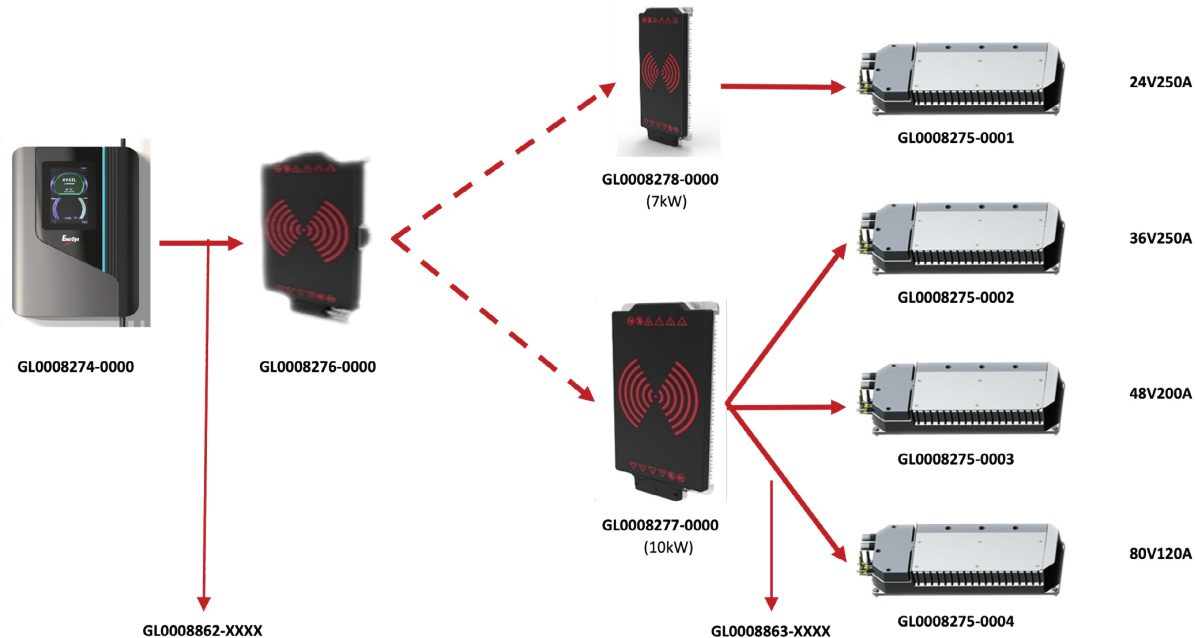
Refresh charge is triggered by battery min voltage and lasts for an hour, 24 hours after the charge finishes. The battery must be connected to the charger all the time to trigger a refresh charge (or over an extended period of time).

Refresh charging can be set on the Wi-iQ4™ battery monitoring device, which will trigger the wireless charger accordingly.

# TECHNICAL INFORMATION

## Technical Information (cont.)

### Wireless Charger Part List



### Part Numbers

North America	Other Regions	Description
GL0008274-1000	GL0008274-0000	Primary Converter
GL0008276-1000	GL0008276-0000	Primary Pad
GL0008275-1001	GL0008275-0001	Secondary Converter 7kW 24V 250A
GL0008275-1002	GL0008275-0002	Secondary Converter 10kW 36V 250A
GL0008275-1003	GL0008275-0003	Secondary Converter 10kW 48V 200A
GL0008275-1004	GL0008275-0004	Secondary Converter 10kW 80V 120A
GL0008278-1000	GL0008278-0000	Secondary Pad 7kW
GL0008277-1000	GL0008277-0000	Secondary Pad 10kW
	GL0008862-XXXX*	Wiring Primary Converter to Pad
	GL0008863-XXXX*	Wiring Secondary Pad to Converter
	GL0008864-XXXX*	Comm Wiring Secondary Converter to Control Module (Li-ion only)
	GL0009925-XXXX*	Comm Wiring Secondary Converter to Wi-iQ® (Lead-Acid only)
	GL0010440-XXXX*	Positive Cable Secondary Converter to Battery
	GL0010439-XXXX*	Negative Cable Secondary Converter to Battery
	GL0012495-0000	Secondary Grounding Cable 10AWG (4 mm <sup>2</sup> )

\*Final digits of part number based on length of cables. Please refer to "Description" column in "Length-Based Part Numbers" table on following page—replacing the "XXXX" portion of part number with four-digit code corresponding to length required.

# TECHNICAL INFORMATION

## Technical Information (cont.)

### Length-Based Part Numbers

Part number*	Description
GL0008862-XXXX*	Primary wiring (Converter to PAD) -2000: 2 m long -5000: 5 m long
GL0008863-XXXX*	Secondary wiring (PAD to Converter) -0500: 0.5 m long -0750: 0.75 m long -1000: 1 m long -2000: 2 m long -3000: 3 m long -5000: 5 m long
GL0008864-XXXX*	CAN cable for lithium battery -0500: 0.5 m long -1000: 1 m long -1500: 1.5 m long -2000: 2 m long -3000: 3 m long

Part number*	Description
GL0009925-XXXX*	CAN cable for lead-acid batteries -0500: 0.5 m long -1000: 1 m long -1500: 1.5 m long -2000: 2 m long -3000: 3 m long
GL0010440-XXXX*	Positive DC lithium cable (3/0) <b>NOTE:</b> Part numbers customized by application. Please contact your EnerSys® representative for details.
GL0010439-XXXX*	Negative DC lithium cable (3/0) <b>NOTE:</b> Part numbers customized by application. Please contact your EnerSys® representative for details.

\*Final digits of part number based on length of cables. Please refer to “Description” column in “Length-based Part Numbers” table above—replacing the “XXXX” portion of part number with four-digit code corresponding to the length required.

## Disclaimer

The procedures provided in this document are valid for any handling and operation of the wireless charger for AGV applications. Even if advice shall be sought by EnerSys, if necessary, it is recommended to use reasonable care in dealing with specific circumstances that may occur that are not covered in the document.

While EnerSys has made reasonable efforts towards the compliance of legal requirements, this documentation is not intended as legal advice and

should not be relied upon as such. It is the user’s responsibility to ensure the proper use of the provided documentation while following all local legal requirements in each respective country if they supersede it.

When producing this manual, EnerSys® has aimed to provide the most accurate and precise information but cannot assume any responsibility for any misinterpretation by the final users.











# SAFETY INSTRUCTIONS

## Safety Instructions

### Safety Precautions

Icon	Description
	Risk for Pacemakers
	Do not Touch
	<ul style="list-style-type: none"> <li>• Radio Frequency</li> <li>• Could affect electronic devices, including pacemakers and other medical devices.</li> <li>• Avoid short circuits: do not use non-insulated tools. Do not place or drop metal objects on top of the chargers.</li> </ul>
	<ul style="list-style-type: none"> <li>• Hot Surface Temperature</li> <li>• Risk of Burns or Damage</li> </ul>

- This manual is intended for the installation, setup, and operation of the wireless charger designed by EnerSys for recharging NexSys® TPPL batteries or NexSys® iON batteries (refer to battery user manuals). This manual should be read through carefully by a skilled user before operating the equipment. Before using the battery charger, read all instructions, cautions, and warnings on the battery charger, the battery, and the product using the battery.
- This wireless charger has been designed to only charge lead-acid and lithium-ion batteries. Read and understand all setup and operating instructions before using the wireless charger to prevent damage to the battery and to the charger.
- The equipment installation location:
  - No obstacles to free circulation of air through the air inlet and outlet of the equipment.
  - Compliance with its indicated level of protection (IP23 for primary converter, IP54 for primary and secondary pad and for secondary converter) and no contact with water for the primary converter.
  - Do not expose the charger to moisture. Operating conditions should be -4° to 113°F (-20° to 45°C); 5 to 95% relative humidity.

Icon	Description
	<ul style="list-style-type: none"> <li>• Risk of Electric Shock</li> <li>• Risk of Explosion and Fire</li> <li>• Dangerous Electrical Voltage!</li> <li>• Avoid short circuits: NexSys® Air Wireless Chargers are capable of high short circuit currents.</li> <li>• Avoid short circuits: do not use non-insulated tools. Do not place or drop metal objects on top of the chargers.</li> </ul>
	<ul style="list-style-type: none"> <li>• Read Owner's Manual</li> <li>• Pay attention to the operating instructions and keep them close to the charger.</li> <li>• Work on chargers must only be carried out by skilled personnel!</li> </ul>

- Primary converter must not be installed on surfaces subject to vibration (near compressors, engines, and motors).
- Primary and secondary converters shall be installed or operating in a location where gases released from the battery during charge shall not be forced into the charger by its fans. Ingress or contact with acid for all parts must be prevented.
- **⚠ CAUTION HOT SURFACE temperatures on primary pad, secondary pad, and secondary converter. Take precautions.**
  - Do not use in ATEX/IECEx area.
- Operators shall take all necessary precautions when the equipment is used in areas deemed to be at risk of accident. Ensure appropriate ventilation according to standard IEC 62485-3/6 to allow any gases released to escape.
- During charge, batteries produce hydrogen gas, which can explode if ignited. Never smoke, use an open flame, or create sparks in the vicinity of the battery. Ventilate well when the battery is in an enclosed space.
- Lead-acid batteries contain sulfuric acid, which causes burns. **Do not** get in eyes, on skin, or on clothing. In cases of contact with eyes, flush immediately with clean water for 15 minutes. Seek medical attention immediately.



## Safety Instructions (cont.)

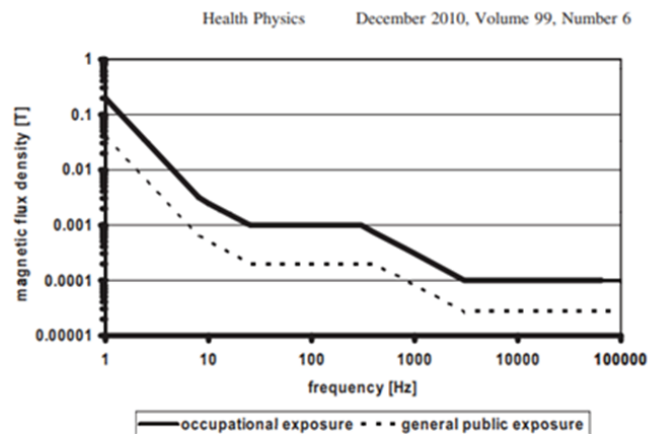
### Electrical Safety

- The prevailing local safety regulations must be observed. The protection system installed on the power supply of the charger must conform to the charger's electrical characteristics. The installation of a suitable circuit breaker is recommended.
- It is imperative to ensure that, in case of fuse replacement, only fuses of the same specified type and size are used. It is strictly forbidden to use inappropriate fuses or to short-circuit the fuse holders.
- This equipment conforms to Class 1 safety standards, which means that the appliance must be grounded and is required to be powered from a grounded supply. Primary ground has to be connected with the ground supply and between the primary converter and the primary pad using the provided cable.
- Secondary: electrical connection between the different chassis is needed. Make the electrical connection between the pad chassis and the secondary converter chassis using the provided cable. An additional electrical connection is needed between these parts to the vehicle chassis and battery tray.
- The battery minus or positive are floating: There is no electrical connection with the chassis.
- Never open the equipment: high voltage could be still present even after turning off the charger. Contact an EnerSys-trained technician if any problem is encountered when putting the charger into operation.
- Only factory-qualified personnel should service this equipment. De-energize all AC and DC power connections before servicing the charger.
- This equipment has been designed for **indoor use**. It is only designed to recharge lead-acid batteries and lithium-ion batteries for industrial applications.
- If the charger needs to be stored before its use, it must be kept sealed in its original packaging. It must be stored in a clean and dry location at a moderate temperature -13°F to 104°F (-25°C to +55°C for a short period not exceeding 24 hours at up to 158°F [70°C]). Equipment stored at a temperature of less than 59°F (15°C) must be brought gradually to ambient temperature (over a period of 24 hours) to avoid any risk of condensation that may cause electrical faults.

### Electromagnetic Field (EMF) Safety

#### Field Exposures

- Wireless charging is accomplished through the coupling of a primary and a secondary coil, which transfers energy at high magnitudes. This involves the generation and transmission of electrical and magnetic fields that can be potentially dangerous to the user or others in the vicinity of the vehicle while charging.
- EMF transmission between the primary pad and secondary pad mainly occurs during charging when the two pads are aligned.
- Low EMF ( $< 0.1 \mu\text{T}$ ) is generated and transmitted by the individual pads, not in charging mode.
- The wireless charger system is designed to protect the user from exposure to these fields. A restricted area within about 20 cm around the charging station presents a field exposure limit that is higher than the maximum limits defined in the safety standards (ICNIRP).
- According to **Figure 1** extracted from ICNIRP standard, at 100kHz (magnetic field frequency of the wireless charger) the flux density from which the safety of human beings can be guaranteed is  $27 \mu\text{T}$  for general public exposure and  $100 \mu\text{T}$  for occupational exposure. We will refer to  $100 \mu\text{T}$  for occupational exposure as a reference level.
- The IEC 61980 has established some



**Figure 1:** Reference levels for exposure to time varying magnetic fields.

experimental procedures to check if the device is safe:

- The measurement probe must be placed 20 cm from the device.
- The measurement values must be compared to the reference levels from the ICNIRP guideline ( $100 \mu\text{T}$  for occupational exposure).
- The measurement must be carried out in the worst-case scenario (10kW with maximum distance between primary and secondary pad of 50 mm) of magnetic field generation.

# SAFETY INSTRUCTIONS

## Safety Instructions (cont.)

**Figure 2:** The magnetic flux density is quantified in the border of the area presented.

Borders of the area of human exposure to electromagnetic fields are defined by the standards.

The measurement points are chosen to be localized in regions of maximum flux density in the cartographies presented in **Figure 3**.

### X Measurement points

- Projection of the measurement points in the PAD area.

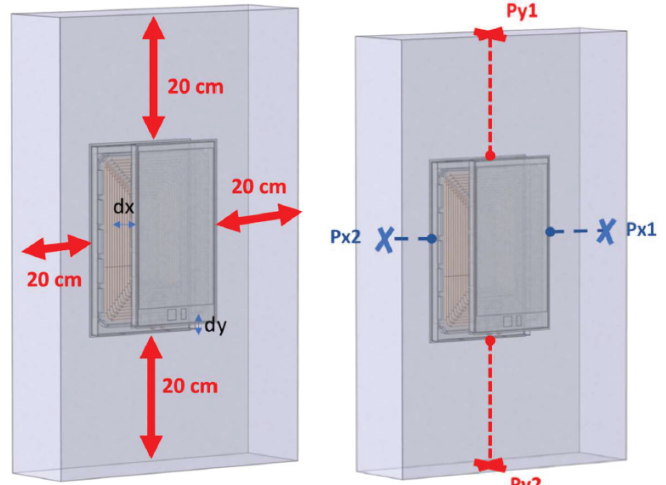


Figure 2

Figure 3

Charging Phase	Measurement Distance	Flux Density ( $\mu\text{T rms Value}$ )
10kW	20 cm	$5\mu\text{T}$ (5Hz to 100kHz)
10kW	5 cm	$13\mu\text{T}$ (5Hz to 100kHz)

- At 20 cm from the device, the magnetic field exposure with 10kW and 7kW chargers is below the recommended 100  $\mu\text{T}$  for occupational exposure as shown in the summary table above, where the actual magnetic flux density has been measured and compared with FEA analysis.
- Experimental measurements of the magnetic flux density within the safety area (20 cm) have been carried out according to the IEC 61980 and shown

that its magnitude is 20 x less than the value recommended by ICNIRP standard (occupational exposure) when operating NexSys® Air charger.

- For medical devices, the limit is 15  $\mu\text{T rms}$  or 21.2 $\mu\text{T}$  peak-to-peak as specified in the table below according to SAJ2954, which is equivalent to a measured distance of 5 cm around the perimeter of the pads (see table above).

Magnetic field limits (Peak field strength and rms)	21.2 $\mu\text{T}$ peak or 16.9Am peak Corresponding to 15 $\mu\text{T rms}$ or 12A/m rms
--	--

# PROTECTIVE MEASURES

## Protective Measures

ICNIRP notes that the protection of people exposed to electric and magnetic fields could be ensured by compliance with all aspects of these guidelines.

Measures for the protection of workers include engineering and administrative controls and personal protection programs. Appropriate protective measures must be implemented when exposure in the workplace results in the basic restrictions being exceeded. As a first step, engineering controls should be undertaken wherever possible to reduce device emissions of fields to acceptable levels. Such controls include good safety design and, where necessary, the use of interlocks or similar health protection mechanisms.

The wireless charger provides three engineering controls to prevent the users from field exposure:

- LED alarm system turns on as soon as the charging process starts (Induction LEDs) to signal the operator of the presence of EMF.
- A detection system (Live Object Detection [LOD]) detects objects entering the restricted area and shuts down the charger to prevent any exposure. Extra distance is built into the detective system as a safe margin for the user.
- A detection system (Foreign Object Detection [FOD]) detects metal parts present between the primary and secondary coils, which otherwise could generate overheating during the power transfer. Vertical installation of the two pads prevents the occurrence of this event. Necessary precautions are needed when the pads are installed horizontally. The presence of any metal object within the pads inhibits the functionality of the charger.
- Administrative controls, such as limitations on access and the use of audible and visible warnings, should be used in conjunction with engineering controls. All people getting close to the pads must be trained beforehand.
  - Personal protection measures, such as protective clothing, though useful in certain circumstances, should be regarded as a last resort to ensure the safety of the worker, limiting exposure to time-varying electric and magnetic fields.
  - Training programs need to be internally developed and implemented to inform users on how to operate the wireless equipment safely.

- Apart from protective clothing and other personal protection, the same measures can be applied to the general public whenever there is a possibility that the general public reference levels might be exceeded. It is also essential to establish and implement rules that will prevent:
  - Interference with medical electronic equipment and devices (including cardiac pacemakers).
  - Detonation of electro-explosive devices (detonators).
  - Fires and explosions resulting from the ignition of flammable materials by sparks caused by induced fields, contact currents, or spark discharges.
- Administrative controls for interference with medical electronic equipment and devices (including cardiac pacemakers):
  - Placement of warning signs around the charging station area such as the following should be posted in dependence upon the EMF field safety distance discussed above. Ultimately it is at the discretion of the user to define the minimum safety distance, but 36 inches (90 cm) away from the EMF source is the minimum recommended distance to post the warning signs. So, if a 36 inch (90 cm) area around the charger constitutes the first boundary limit, adding an extra 4 inches (10 cm) to it would extend the safety boundary limit to 40 inches (100 cm) in all directions, which defines the area to place the warning sign.
- Pacemaker warning sign examples:



**IMPORTANT:** Danger/Warning signs about the hazards of this equipment to those with pacemakers or similar medical devices—to be placed at locations around the charger(s) as described by the text in this section.

# MECHANICAL INSTALLATION

## Mechanical Installation

**Location:** For safe operation, choose a location that is free of excess moisture, dust, combustible material, and corrosive fumes. Also, avoid high temperatures (above 113°F [45°C]) or potential liquid spills on the primary and secondary converters.

Do not obstruct the openings in the primary and secondary converter for air ventilation.

Follow the charger warning label when mounting on or over a combustible surface.

**Primary converter mounting:** The primary converter box shall be mounted on a wall, a stand (floor mounting), or a shelf for easy access and visibility.

**Wall mounting installation:** Wall mounting plate support must be installed using 4 screws: M5 flat countersunk head (see image at right – screws not included). The primary converter must be positioned on top of the plate and secured with 2 screws.

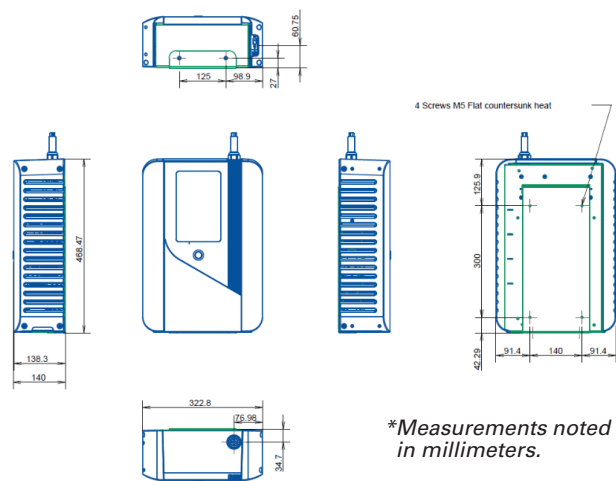
M4x10 (included in the box). The charger should be permanently fastened in place. Make sure the surface is free of vibrations and the charger is mounted in a vertical position.

The primary converter should be spaced at least 30 cm from the pad to operate correctly.

**For stand mounting installation:** refer to the specific installation manual.

If wall-mounted, make sure that the surfaces are free of vibration, water, and humidity. You must avoid areas where the chargers may be splashed with water.

**Primary pad mounting:** For stand mounting installation, see mounting instructions, etc. The primary pad is mounted on a vertical rail that allows for vertical adjustment of the pad to ensure a perfect alignment with the secondary pad.



**Electrical connection:** To prevent failure of the charger, make sure it is connected to the correct line voltage. Follow your local and National Electric Code (NEC) in making these connections.

**⚠ WARNING** Make sure the power source is OFF = disconnected when installing primary converter, primary cable and primary pad.

**Connecting the primary converter to the primary pad:** The primary converter is connected to the primary pad via a power cable and communication cable:

Only use cable provided by EnerSys:

- Specific power cable
- Ground cable (yellow-blue)
- Communication cable (via Molex)

**Connecting primary converter to input power:** For detailed installation instructions, please refer to the OEM Installation Manual.

Primary converter shall only be connected to a 3-phase 400/480Vac mains supply using a standard socket and an appropriate circuit breaker (not supplied). It comes without an AC connector with bare wires, so install the most suitable connector according to the electrical technical specs in the table on the following page.

# MECHANICAL INSTALLATION

## Mechanical Installation (cont.)

Nominal Power		7kW	10kW
Nominal Voltage – Frequency	Primary Converter	3-phase – 400/480Vac ± 10 % – 50/60Hz	
Max current draw @400Vac	Aac	12	17
Max current draw @480Vac	Aac	10	14
AC input cable section	AWG	4x10	
AC input cable length	m	2	
Power factor		0.95	

3-phase chargers are not phase rotation sensitive and work with either Delta or Wye wound transformers.

**AC circuit protection:** The user must provide suitable branch circuit protection and a disconnect method from the AC power supply to the charger to allow for safe servicing.

**⚠ CAUTION Risk of Fire.** Use only on circuits provided with branch circuit protection in accordance with the Breaker/Fuse Chart table in this manual (valid for US only), and the National Electrical Code, NFPA 70.

AC Amps (A)	Breaker/Fuse size (A)
1–12	15
12.1–16	20
16.1–20	25

**Grounding the charger:** Connect ground wire to terminal marked with either of the two symbols below and apply same torque value per table above:



**⚠ DANGER FAILURE TO GROUND THE CHARGER COULD LEAD TO FATAL ELECTRIC SHOCK.** Follow the National Electric Code for ground wire sizing.

### DC connector selection guide

**DC plug polarity:** The charging cables are connected to the DC output of the charger: the red charging cable (POS) is connected to the positive busbar of the charger, and the black charging cable (NEG) is connected to the negative busbar of the charger. The output polarity of the charger must be observed when connecting to the battery (read warning). **Improper connection will open the DC fuses in the secondary converter.**

Wireless Power	Max DC Amps (A)	Cable Gauge	Breaker/Fuse Size (A)
24V; 7kW	250	3/0	160
36V; 10kW	250	3/0	160
48V; 10kW	200	3/0	125
80V; 10kW	120	3/0	50



# OPERATING INSTRUCTIONS

## Operating Instructions

### Mode of Operation

#### Normal functioning

The charge will start automatically without any user interaction when the position of the secondary pad on the vehicle is aligned with the primary pad. The charge will stop as soon as the vehicle moves, regardless of the state of charge of the battery.

Please verify the relative positioning of the two pads (air gap distance and alignment) if the charge does not start. Air gap from 0.8" (20 mm) to 2" (50 mm) and misalignment below +/- 0.8" (20 mm) are required for correct operation. Charger will not start if these conditions are not met, or it will stop charging if these conditions are violated.

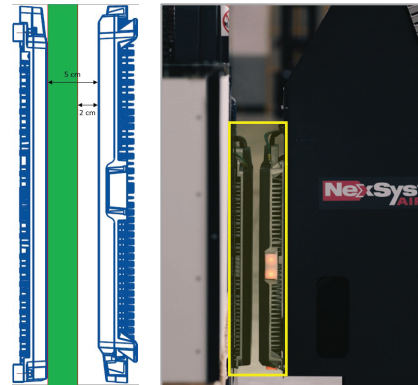
At charge completion (battery fully charged), the display on the primary converter will signal charge termination.

If AGV is left idle on the charger after charge completion, the wireless charger will automatically enter the refresh mode, if the battery's voltage condition (minimum voltage) is met (ONLY for lead-acid batteries).

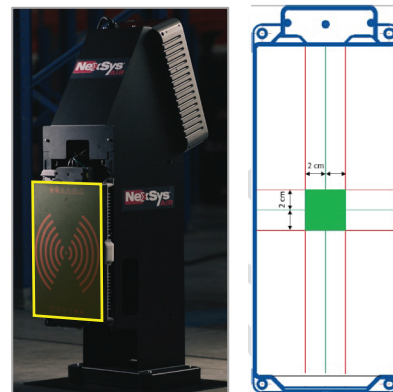
**Figure 4:** Air gap limits: minimum 20 mm and maximum 50 mm.

**Figure 5:** Misalignment limits: +/- 20 mm vertical and horizontal.

Illustrations not to exact scale

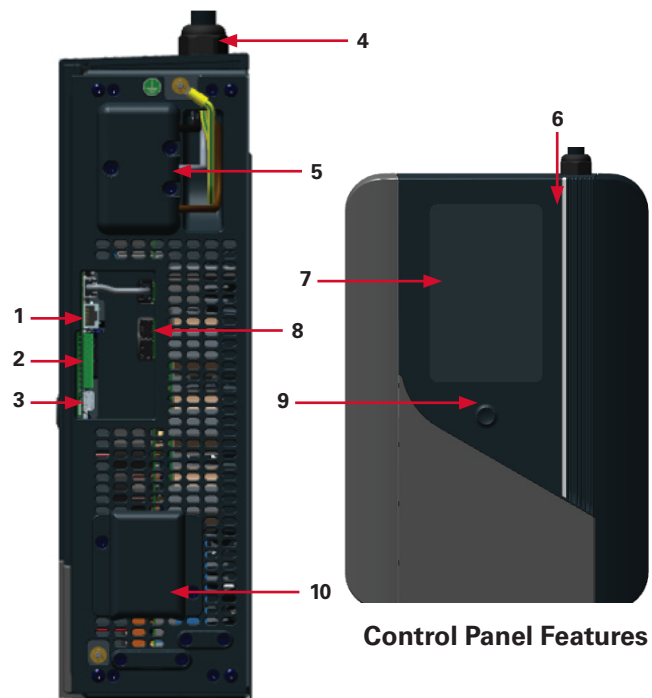


**Figure 4**



**Figure 5**

Ref	Description
1	Ethernet Port
2	PLC Port
3	USB Port
4	AC Cable Input
5	AC Cable Internal Connection
6	LED Status Bar
7	7" Touchscreen Display
8	CAN Port for Primary Pad
9	Start/Stop Charge Push Button
10	Connection Point for Primary Litz Cable



**Control Panel Features**

## Operating Instructions (cont.)

### Switch ON/OFF Primary Converter

To switch the primary converter ON, connect it to the grid according to the correct voltage indicated on the label. To switch OFF, disconnect from the grid while the charge is stopped (use Start/Stop button if needed).

If the screen is black (idle) touch the screen or use push button ref. 9 of the previous section.

### Connect Battery

**Charge display menu:** with the charger in wait mode (no battery connected) and without pressing the Start/Stop button, the display will show the following information in **Figure 6**.

Ref	Description
1	Charger information (in parallelization mode)
2	Start button
3	Menu settings

### Battery Connected and Pad Paired

**Main display:** When a secondary pad is correctly aligned to the primary pad (refer to instructions), primary and secondary pad will be automatically paired. The information in **Figure 7** is always shown in the main display.

Ref	Description
1	Battery DC voltage
2	Ah (ampere hours) Charge by the wireless charger
3	Charger information (in parallelization mode only)
4	Charging profile
5	Start button (to start the charge)
6	Menu settings

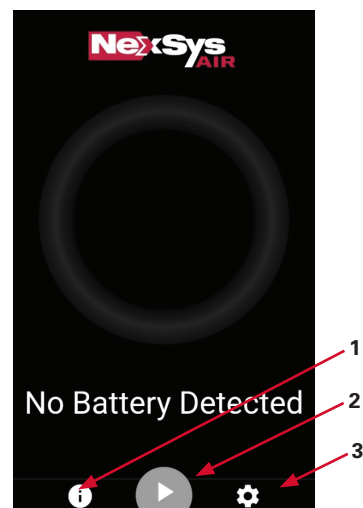


Figure 6

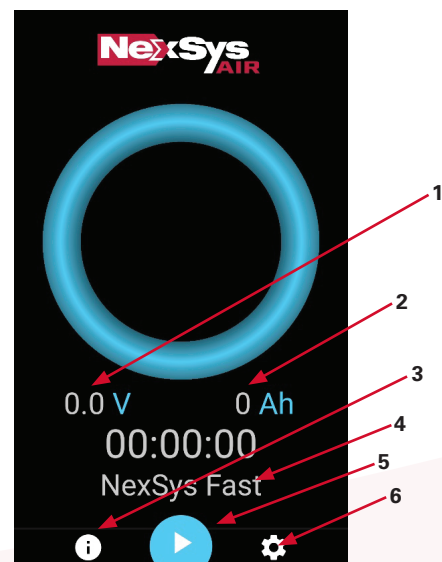


Figure 7



# OPERATING INSTRUCTIONS

## Operating Instructions (cont.)

### Start Charging Display

Once pads are paired, battery and charger information is displayed after a short delay; the charge starts **automatically**.

Push the Start/Stop button to pause the charge or to re-engage the charge.

**Figure 8:** As the battery charges, the graphical display will output various charge parameters, including battery voltage (1), percentage of battery capacity (battery SoC) (2), current delivered by the charger (3), Ah accumulated (4), the dynamic cycle in orange color, and charging time (5).

Ref	Description
1	Battery Voltage
2	Battery SoC
3	Current Delivered by the Charger
4	Ah Recharged
5	Charging Time



Figure 8

**NOTE:** Charging current (3) is determined by the battery voltage and state of charge condition for lead-acid batteries. Charging current normally declines as battery voltage rises during the charge.

### Stop Charging

Charger can be stopped:

- By pushing the Start/Stop button.
- Automatically once the vehicle leaves and there is no pairing of the pads.
- Remotely using Ethernet/WiFi or CANOpen controls.
- Once the charger is stopped, it displays the SoC % and battery voltage on the main display. The dynamic circle turns blue. See **Figure 9**.

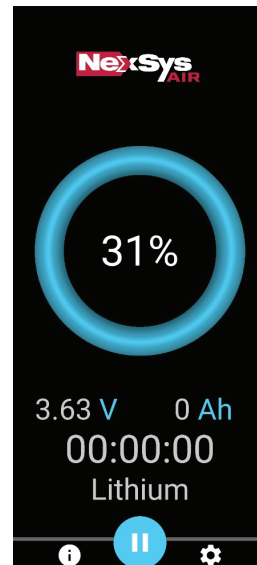


Figure 9

# OPERATING INSTRUCTIONS

## Operating Instructions (cont.)

### Charge Complete

#### End of Charge without Equalization

Once the charge is complete, the LED status bar turns green and the charge display shows SoC equal to 100% with the dynamic circle fully completed and turning green. All visuals indicate CHARGE COMPLETE.



The display alternates between:

- Total charging time.
- Amp-hours restored to the battery.

#### End of Charge with Equalization

An equalize charge can be **started manually or automatically**.

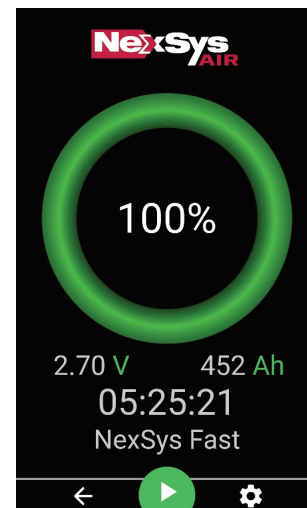
#### Manual Equalization Start

- Only for lead-acid batteries, press the <EQUALIZE> button (symbolized by ) in the Settings menu.
- During the equalization charge, the charger displays the output current, the battery voltage and voltage per cell, and the remaining time. On the screen, the symbol  is also displayed.

**NOTE:** When an equalize charge is manually started, the equalization charge values follow the settings preconfigured in the Wi-iQ<sup>®</sup> monitoring device.

#### Automatic Equalization Start

- The equalization is automatic by default. The equalization parameters are requested by the Wi-iQ<sup>®</sup> monitoring device following the profile parameters, and the charger will start at the end of the full charge.



End of Charge Display

#### Refresh Charge (lead-acid batteries only)

- If AGV is left idle on the charger after charge completion, the wireless charger will automatically enter the refresh mode, if the battery's voltage condition (minimum voltage) is met.

#### AC Power Fail

If the AC power fails during a charge cycle, the charger will reset **and restart where it left off** when power is restored. All charger settings, as well as the time and date, are preserved.

# SETTINGS MENU INFORMATION

## Settings Menu Information

### Setting Display Menu

From the main display menu, by pressing the Settings logo the Settings menu is then displayed. See **Figure 10**.

By clicking the key  from the charger setting menu, a password prompt is required to enable. See **Figure 11**.

Ref	Description
1	WiFi Connected
2	Battery Connected

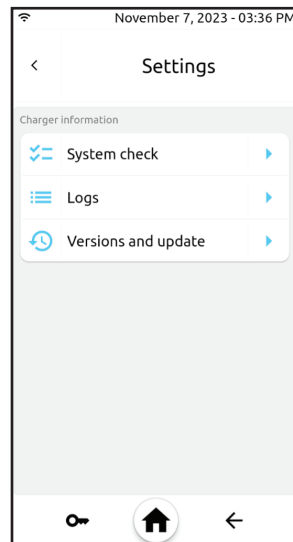


Figure 10

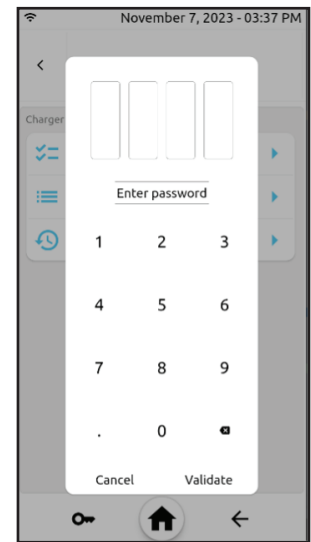
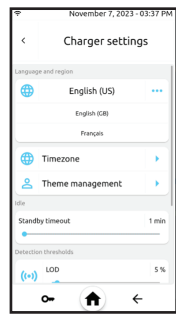


Figure 11

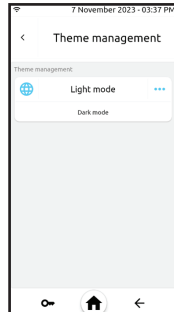
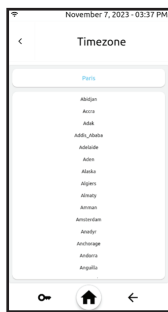
Under Charger settings, the user can access the following parameter:

- Language (change the language)

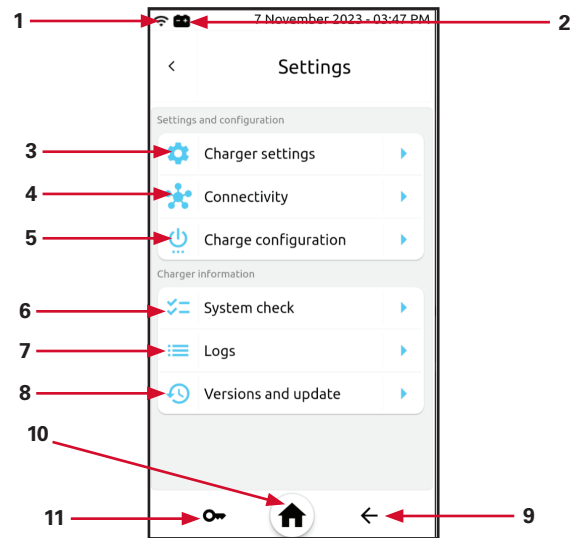
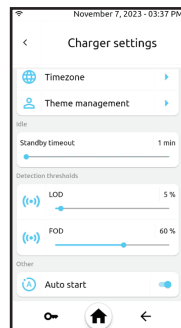


3

- Timezone
- Themes (Day/ Night)
- Standby timeout



- LOD/FOD regulation and Auto start
- LOD and FOD can be adjusted from low sensitivity (lower %) to high sensitivity response (higher %). Values presented are just for reference purposes.
- Auto start is ON by default.

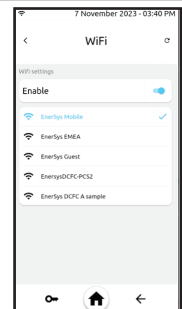
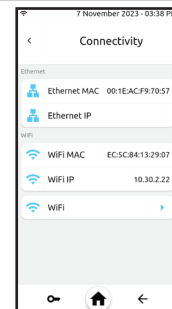


### Ref Description

4

Connectivity menu allows access to the following parameters:

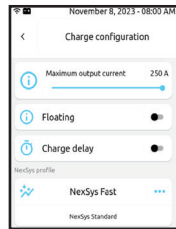
- Ethernet IP address
- WiFi IP address



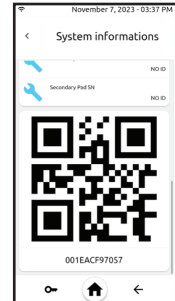
# SETTINGS MENU INFORMATION

## Settings Menu Information (cont.)

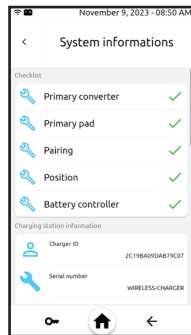
Ref	Description
5	<p>Charge configuration menu allows access to the following parameters:</p> <ul style="list-style-type: none"> <li>Maximum current delivered by the charger: Set the maximum battery current (value at right is an example)</li> <li>Delayed charge: time delay to start of the charge. The charger will start the charge after the delay set by the user</li> <li>Floating: specify the current to compensate the AGV consumption</li> <li>NexSys® Battery Profile: it's possible to select a standard recharge or a fast recharge. All other profiles are activated by the Wi-iQ® device or CDI connected to the battery.</li> </ul> <p><b>NOTE:</b> The recharge is never starting if the Wi-iQ® device or the CDI are not connected.</p>



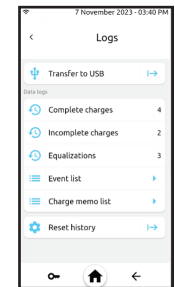
Ref	Description
6 Cont.	<p>...and to see the QR code for the remote assistance (if connected to the internet).</p>



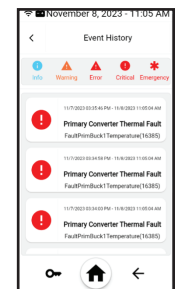
6	<p>System informations menu allows access to the following parameters:</p> <ul style="list-style-type: none"> <li>Primary converter information</li> <li>Primary pad information</li> <li>Pairing</li> <li>Position</li> <li>Battery controller</li> </ul> <p>To start the charge, all the boxes must have a check mark.</p>
---	--



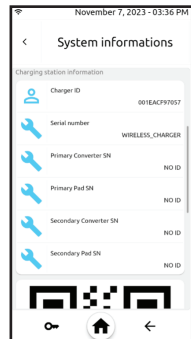
7	<p>Logs menu allows access to the following parameters:</p> <ul style="list-style-type: none"> <li>Transfer all information related to all recharges into USB as a compressed format file.</li> <li>Data Logs shows the number of complete/incomplete and equalization charges.</li> </ul>
---	--



7	<p>Event History shows the cycle details:</p>
---	---



6	<p>It is possible to also see the serial numbers of all the part...</p>
---	---



6	<p>Charger memo list shows the list of all recharges:</p>
---	---

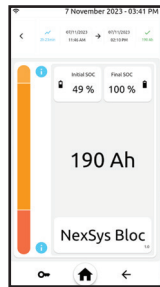
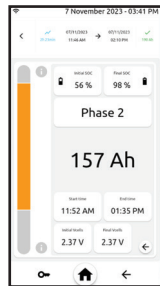


# SETTINGS MENU INFORMATION

## Settings Menu Information (cont.)

7  
Cont.

The green Ah means the charge is complete, the orange Ah means the charge has been stopped manually. By clicking on the single recharge it's possible to see the details split by charge phase.



9 Arrow button allows you to return to previous charger menu.



10 Home button takes you back to the main screen.



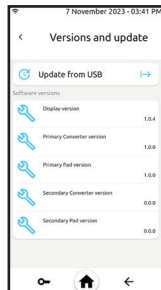
11 Settings button allows access to Settings menu.



8

Version and update menu allows access to the following parameters:

- Update via USB: Allows reprogramming of software (display, primary converter, pad, and secondary converter).
- Software versions: Allows access to software information of each individual subsystem (display, primary converter, pad, and secondary converter).

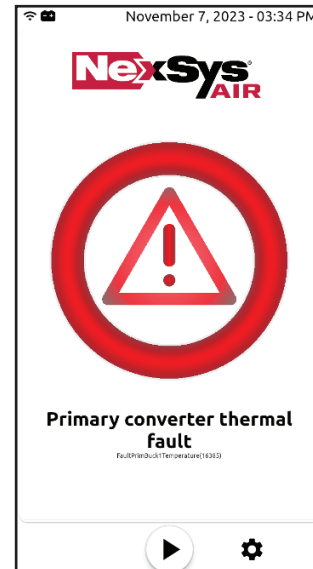


# TROUBLESHOOTING






## Service and Troubleshooting

### Fault Display

In case of a fault, one of the corresponding fault codes listed below will appear on the display. If it is a critical fault, charging will stop and the Red Fault LED will be illuminated.



### Error levels

Level	Symbol	Error	Impact
1	 Emergency	Blocking	Charge is stopped, error not cleared.
2	 Critical	Blocking after fault reoccurrence	The recharge is stopped if the error occurs multiple consecutive times. Fault counter is reset every new charge.
3	 Error	Blocking automatic restart	Automatic restart
4	 Warning	Derating	Charge is derated
5	 Info	Non-blocking	Alert

### Error Messages

User Message	Effect	Description	Solution	Level
Metal part detected	Stop charge (no retry).	Foreign object detected to primary pad. Please check.	Manual restart after clearing metal parts from pad surface.	1
Living object detected	Stop charge (retry indefinitely with 5 seconds between each retry).	Living object detected. Ensure no one is standing near the pads during charge.	Automatic restart.	3

# TROUBLESHOOTING

## Service and Troubleshooting (cont.)

User Message	Effect	Description	Solution	Level
Power derating warning	Power derating 20%.	Primary converter high temperature. Power limitation enabled.		4
Primary converter thermal fault	Stop charge (retry 3 times).	Primary converter too high temperature. Charge is stopped to cool down.	Automatic restart after cooling off.	2
Primary pad thermal fault	Stop charge (retry 3 times).	Primary pad too high temperature. Charge is stopped to cool down.	Automatic restart after cooling off.	2
Secondary thermal fault	Stop charge (retry 3 times with 10 seconds between each retry).	Secondary converter too high temperature. Charge is stopped to cool down.	Automatic restart after cooling off.	2
Power derating warning	Power derating 20%.	Secondary converter high temperature. Power limitation enabled.		4
Secondary converter thermal fault	Stop charge (retry 3 times with 10 seconds between each retry).	Secondary converter too high temperature. Charge is stopped to cool down.	Automatic restart after cooling off.	2
Power derating warning 2	Power derating 40%.	Secondary converter high temperature. Power limitation enabled.		4
Secondary pad thermal fault	Stop charge (retry 3 times with 10 seconds between each retry).	Vehicle pad too high temperature. Charge is stopped to cool down.	Automatic restart after cooling off.	2
Power derating warning 3	Power derating 15%.	Secondary converter high temperature. Power limitation enabled.		4
No communication Pads between pads during the charging process	Stop charge (retry 5 times with 5 seconds between each retry).	Pad communication timed out.	Manual restart—Call service if not cleared.	2
Primary converter fault 1	Stop charge (retry 5 times with 5 seconds between each retry).	Primary converter phase regulation fault.	Manual restart—Call service if not cleared.	2
Primary converter fault 2	Stop charge (retry 5 times with 10 seconds between each retry).	Primary converter overcurrent protection.	Manual restart—Call service if not cleared.	2

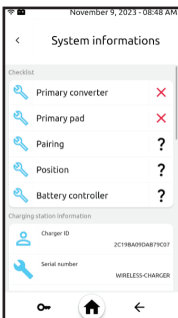


# TROUBLESHOOTING

## Service and Troubleshooting (cont.)

User Message	Effect	Description	Solution	Level
Primary converter fault 3	Stop charger (vehicle count >3).	Primary converter overcurrent protection.	Manual restart—Call service if not cleared.	1
No communication with primary	Stop charge (retry 5 times with 5 seconds between each retry).	CANbus fault.	Manual restart—Call service if not cleared.	2
	Stop charge (retry 5 times with 5 seconds between each retry).	CANbus fault.	Manual restart—Call service if not cleared.	2
Primary pad fault	Stop charge (no retry).	Primary pad LED fault.	Manual restart—Call service if not cleared.	1
	Reset faults.	The vehicle has left!		5
Secondary controller fault	Stop charge (no retry).	If the green light on secondary converter is blinking, the DC fuse is blown (reversed polarity).	Double check polarities and replace fuse. If not resolving, call service.	1
Battery controller not found. Charge not authorized.	Stop charge (no retry).	CAN communication issue with battery.	Check CAN cable connection. Update firmware Wi-iQ® or CDI. If not resolving, call service.	1

Primary converter not checked



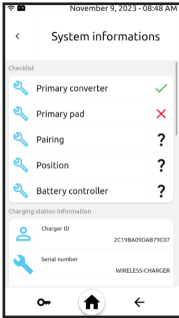
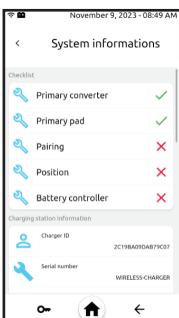
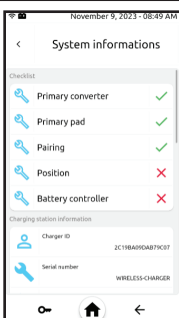
Stop charge (no retry).

If primary converter is NOT checked, verify the following:

- AC connected
  - AC plug
- Call service if not cleared.

# TROUBLESHOOTING

## Service and Troubleshooting (cont.)

User Message	Effect	Description	Solution	Level
<p>Primary pad not checked</p> 	Stop charge (no retry).		Connection cable between primary converter and pad. Call service if not cleared.	
<p>No pairing</p> 	Stop charge.	Missing communication between the pads.	<p>If Pairing is NOT checked, verify the following:</p> <ul style="list-style-type: none"> <li>• Issue with communication with Wi-iQ® via CAN.</li> <li>• Issue with communication with lithium via CAN.</li> <li>• Battery not powering converter.</li> <li>• Battery not present.</li> </ul> <p>Call service if not cleared.</p>	
			Missing Wi-iQ® or CDI. Check the device or the connection cable with the secondary converter—Call service if not cleared.	
Wrong system installation	Stop charge (no retry).	Pad power not compatible with Converter voltage.	Manual restart—Call service if not cleared.	1
Wrong system installation Battery issue	Stop charge (no retry).	Battery cells voltage lower than 1.6V or higher than 2.4V per cell. Please check.	Manual restart—Call service if not cleared.	1
Wrong system installation Battery issue 2	Stop charge (no retry).	Battery technology not compatible. Check Battery controller setting.	Manual restart—Call service if not cleared.	1

When the error is blocking and there is the need to call for service, the error code (numeric) must be provided.

## Service and Troubleshooting (cont.)

### Maintenance and Service

**⚠ WARNING** THERE ARE DANGEROUS VOLTAGES WITHIN THE BATTERY CHARGER CABINET. ONLY A QUALIFIED PERSON SHOULD ATTEMPT TO ADJUST OR SERVICE THIS BATTERY CHARGER.

The charger requires minimal maintenance. Connections and terminals should be kept clean and tight. The unit (especially the heat sink) should be periodically cleaned with low-pressure air to prevent any excessive dirt buildup on components. Care should be taken not to bump or move any adjustments during cleaning. Make sure that both the AC lines and the battery are disconnected before cleaning. The frequency of this type of maintenance depends on the environment in which this unit is installed.

For service, contact your sales representative.

For US only, call: 1-800-ENERSYS  
(USA) 1-800-363-7797

Any data, descriptions, or specifications set forth herein are subject to change without notice. Before using the product(s), the user is advised and cautioned to make their own determination and assessment of the suitability of the product(s) for the specific use in question and is further advised against relying on the information contained herein as it may relate to any general use or indistinct application. It is the ultimate responsibility of the user to ensure that the product is suited, and the information is applicable to the user's specific application. The product(s) featured herein will be used under conditions beyond the manufacturer's control and therefore all warranties, either express or implied, concerning the fitness or suitability of such product(s) for any particular use or in any specific application, are disclaimed. The user expressly assumes all risk and liability, whether based in contract, tort, or otherwise, in connection with the use of the information contained herein or the product itself.

[www.enersys.com](http://www.enersys.com)

© 2024 EnerSys. All rights reserved. Trademarks and logos are the property of EnerSys and its affiliates except UL, CE, MET, Molex, and UK CA, which are not the property of EnerSys. Subject to revisions without prior notice. E.&O.E.

GLOB-EN-OM-NEX-AIR 0424

