

ODYSSEY[®] **BATTERY**

ODYSSEY[®] Shop Charger

***Models: OSC-70A
OSC-105A***

AUTOMATIC BATTERY CHARGER Instruction Manual

To automatically be connected to your closest Service Center, call us toll-free at:
1-800-ENERSYS (1-800-363-7797)

AM-OSC3BAY-IM
Rev AA August 2019

IMPORTANT

Read and understand your instruction manual before installing, operating or servicing this product.

DO NOT DESTROY THIS MANUAL, SAVE IT FOR FUTURE REFERENCE

TABLE OF CONTENTS

Safety Guidelines/Definitions	2	Parameters	20
Important Safety Instructions	2	Date/Hour	20
Technical Information	9	Language	20
UL Model and Part Number.....	9	Region.....	20
UL Model Number	9	Display	20
Part Number.....	9	Screen Saver.....	20
Output Power Letter Codes.....	9	Delay	20
Cabinet Size Letter Code	10	Themes	21
DC Voltage Number Code	10	Daylight Saving	22
Input Voltage Letter Code	10	Password	22
Serial Number	10	Starting the Charge Cycle	23
Battery Type	10	Connecting to the Battery	23
Modules	10	Delayed Start.....	23
AC Volts.....	10	Count Down Display	23
AC Amps.....	10	Charger Display.....	24
Hertz	11	End of Charge Display.....	25
Phase	11	End of Charge	25
DC Amps	11	Disconnecting the Battery.....	26
DC Volts.....	11	Fault Codes	27
CEC.....	11	Fault Display	27
cULus	11	Maintenance Instructions	29
FCC.....	11	Moving and Storage Instructions	29
Introduction	12	Cabinet Mounting Dimensions	30
AC Power Fail.....	12	Technical Specifications	31
Series Charging	12	Fuse Replacement	32
Charging Profile	12	Maintenance Log	33
ODY Profile.....	12		
Equalization Charging.....	12		
Refresh Charging.....	12		
Features	13		
Control Panel	13		
Installation	14		
Charger Location	14		
Shelf Mounting	14		
DC Plug Polarity.....	14		
Assembly Instructions	14		
Preparing the Charger	15		
Connecting AC Power.....	15		
Main Menu	16		
Logs.....	17		
Memorizations Display Screen ...	17		
Displaying a Charge Cycle	17		
Memorization Data	17		
Status	18		
Status Screen.....	18		
Charger.....	19		
Information	19		
USB	20		
Update Software	20		
Settings.....	20		

SAFETY GUIDELINES / DEFINITIONS

▲ DANGER: Indicates an imminently hazardous situation which, if not avoided, will result in death or serious injury.

▲ WARNING: Indicates a potentially hazardous situation which, if not avoided, could result in death or serious injury.

▲ CAUTION: Indicates a potentially hazardous situation which, if not avoided, may result in minor or moderate injury, and in property damage.

RISK OF UNSAFE OPERATION. When using any tools or equipment, basic safety precautions must be followed to reduce the risk of personal injury. Improper operation, maintenance or modification of this charger could result in serious injury and property damage. This charger is designed for a specific application. EnerSys® strongly recommends that this product NOT be modified and/or used for any application other than for which it was designed. Read and understand all warnings and operating instructions before using this equipment.

IMPORTANT SAFETY INSTRUCTIONS

- **SAVE THESE INSTRUCTIONS** - This manual contains important safety and operating instructions for this battery charger. Before using the battery charger, read all instructions, **cautions** and **warnings** on the battery charger, the battery and the product using the battery.
- Do not expose charger to rain or snow. The charger is **not** for outdoor use.
- Use of an attachment not recommended or sold by the battery charger manufacturer may result in a risk of fire, electric shock or injury to persons.
- To reduce risk of damage to electric plug and cord, pull by plug rather than cord when disconnecting charger.
- An extension cord should not be used unless absolutely necessary. Use of improper extension cord could result in a risk of fire and electric shock. If an extension cord must be used, make sure:
 - 1) That pins on plug of extension cord are the same number, size and shape as those of plug on charger;
 - 2) That extension cord is properly wired and in good electrical condition; and
 - 3) That wire size is large enough for AC ampere rating of charger as specified below:

AC input rating, amperes		AWG size of cord			
		Length of cord, feet (m)			
Equal to or greater than	But less than	25	50	100	150
		(7.6)	(15.2)	(30.5)	(45.6)
8	10	18	14	12	10
10	12	16	14	10	8
12	14	16	12	10	8
14	16	16	12	10	8

- Do not operate charger with damaged cord or plug - replace the cord or plug immediately.
- Do not operate charger if it has received a sharp blow, been dropped or otherwise damaged in any way; return to manufacturer.
- Do not disassemble charger; contact manufacturer when service or repair is required. Incorrect reassembly may result in a risk of electric shock or fire.
- To reduce risk of electric shock, unplug charger from outlet before attempting any maintenance or cleaning. Turning off controls will not reduce this risk.
- This charger has been designed to charge lead acid batteries. Read and understand all setup and operating instructions before using the battery charger to prevent damage to the battery and to the charger.
- **Do not** connect or disconnect the battery plug while the charger is on. Doing so will cause arcing and burning of the connector resulting in charger damage or battery explosion.
- Do not expose the charger to moisture. Operating **conditions** should be 32° to 113° F (0° to 45° C); 0 to 70% relative humidity.
- For continued protection and to reduce the risk of fire, install chargers on a floor of non-combustible material such as stone, brick or grounded metal.

⚠ WARNING - RISK OF EXPLOSIVE GASES.

- 1) WORKING IN VICINITY OF A LEAD ACID BATTERY IS DANGEROUS. BATTERIES GENERATE EXPLOSIVE GASES DURING NORMAL BATTERY OPERATION. FOR THIS REASON, IT IS OF UTMOST IMPORTANCE THAT YOU FOLLOW THE INSTRUCTIONS EACH TIME YOU USE THE CHARGER.
- 2) To reduce risk of battery explosion, follow these instructions and those published by battery manufacturer and manufacturer of any equipment you intend to use in vicinity of battery. Review cautionary marking on these products and on engine.

- **PERSONAL PRECAUTIONS**

- 1) Consider having someone close by to come to your aid when you work near a lead acid battery.
- 2) Have plenty of fresh water and soap nearby in case battery acid contacts skin, clothing or eyes.
- 3) Wear complete eye protection and clothing protection. Avoid touching eyes while working near battery.
- 4) If battery acid contacts skin or clothing, wash immediately with soap and water. If acid enters eye, immediately flood eye with running cold water for at least 10 minutes and get medical attention immediately.
- 5) NEVER smoke or allow a spark or flame in vicinity of battery or engine.
- 6) Be extra cautious to reduce risk of dropping a metal tool onto battery. It might spark or short-circuit battery or other electrical part that may cause explosion.
- 7) Remove personal metal items such as rings, bracelets, necklaces and watches when working with a lead acid battery. A lead acid battery can produce a short-circuit current high enough to weld a ring or the like to metal, causing a severe burn.
- 8) Use charger for charging a LEAD ACID battery only. It is not intended to supply power to a low voltage electrical system other than in a starter-motor application. Do not use battery charger for charging dry-cell batteries that are commonly used with home appliances. These batteries may burst and cause injury to persons and damage to property.
- 9) Lead acid batteries contain sulfuric acid, which causes burns. Do not get in eyes, on skin, or on clothing. In cases of contact with eyes, flush immediately with clean water for 15 minutes. Seek medical attention immediately.
- 10) NEVER charge a frozen battery.

- **PREPARING TO CHARGE**

- 1) If necessary to remove battery from vehicle to charge, always remove grounded terminal from battery first. Make sure all accessories in the vehicle are off, so as not to cause an arc.
- 2) Be sure area around battery is well ventilated while battery is being charged.
- 3) Clean battery terminals. Be careful to keep corrosion from coming in contact with eyes.

4) Add distilled water in each cell when needed as specified by battery manufacturer. Do not overfill. For a battery without removable cell caps, such as valve regulated lead acid batteries, carefully follow manufacturer's recharging instructions.

5) Study all battery manufacturer's specific precautions while charging and recommended rates of charge.

6) Determine voltage of battery by referring to car owner's manual and make sure it matches output rating of battery charger.

- **DC CONNECTION PRECAUTIONS**

1) Connect and disconnect DC output clips only after setting any charger switches to "off" position and removing AC cord from electric outlet. Never allow clips to touch each other.

2) Attach clips to battery and chassis as indicated in sections 5 and 6 for battery installed in vehicle, and sections 2 through 4 for battery outside vehicle.

- **FOLLOW THESE STEPS WHEN BATTERY IS INSTALLED IN VEHICLE. A SPARK NEAR BATTERY MAY CAUSE BATTERY EXPLOSION. TO REDUCE RISK OF A SPARK NEAR BATTERY:**

1) Position AC and DC cords to reduce risk of damage by hood, door or moving engine part.

2) Stay clear of fan blades, belts, pulleys and other parts that can cause injury to persons.

3) Check polarity of battery posts. POSITIVE (POS, P, +) battery post usually has larger diameter than NEGATIVE (NEG, N, -) post.

4) Determine which post of battery is grounded (connected) to the chassis. If negative post is grounded to chassis (as in most vehicles), see section 5. If positive post is grounded to the chassis, see section 6.

5) For negative-grounded vehicle, connect POSITIVE (RED) clip from battery charger to POSITIVE (POS, P, +) ungrounded post of battery. Connect NEGATIVE (BLACK) clip to vehicle chassis or engine block away from battery. Do not connect clip to carburetor, fuel lines or sheet-metal body parts. Connect to a heavy gage metal part of the frame or engine block.

6) For positive-grounded vehicle, connect NEGATIVE (BLACK) clip from battery charger to NEGATIVE (NEG, N, -) ungrounded post of battery. Connect POSITIVE (RED) clip to vehicle chassis or engine block away from battery. Do not connect clip

to carburetor, fuel lines, or sheet-metal body parts. Connect to a heavy gauge metal part of the frame or engine block.

7) When disconnecting charger, turn switches to off, disconnect AC cord, remove clip from vehicle chassis and then remove clip from battery terminal.

8) See operating instructions for length of charge information.

- **FOLLOW THESE STEPS WHEN BATTERY IS OUTSIDE VEHICLE. A SPARK NEAR THE BATTERY MAY CAUSE BATTERY EXPLOSION. TO REDUCE RISK OF A SPARK NEAR BATTERY:**

1) Check polarity of battery posts. POSITIVE (POS, P, +) battery post usually has a larger diameter than NEGATIVE (NEG, N, -) post.

2) Attach at least a 24-inch-long 6-gauge (AWG) insulated battery cable to NEGATIVE (NEG, N, -) battery post.

3) Connect POSITIVE (RED) charger clip to POSITIVE (POS, P, +) post of battery.

4) Position yourself and free end of cable as far away from battery as possible then connect NEGATIVE (BLACK) charger clip to free end of cable.

5) Do not face battery when making final connection.

6) When disconnecting charger, always do so in reverse sequence of connecting procedure and break first connection while as far away from battery as practical.

7) A marine (boat) battery must be removed and charged on shore. To charge it on board requires equipment specially designed for marine use.

- **GROUNDING AND AC POWER CORD CONNECTION INSTRUCTIONS**

Charger should be grounded to reduce risk of electric shock. Charger is equipped with an electric cord having an equipment-grounding conductor and a grounding plug. The plug must be plugged into an outlet that is properly installed and grounded in accordance with all local codes and ordinances.

▲ DANGER:

Never alter AC cord or plug provided - if it will not fit outlet, have proper outlet installed by a qualified electrician. Improper connection can result in a risk of an electric shock.

- 1) For model OSC-70A, this battery charger is for use on a nominal 120-volt circuit, and has a grounding plug that looks like the plug illustrated in sketch (A) below. A temporary adapter, which looks like the adapter illustrated in sketches (B) and (C), may be used to connect this plug to a two-pole receptacle as shown in sketch B if a properly grounded outlet is not available. The temporary adapter should be used only until a properly grounded outlet can be installed by a qualified electrician.

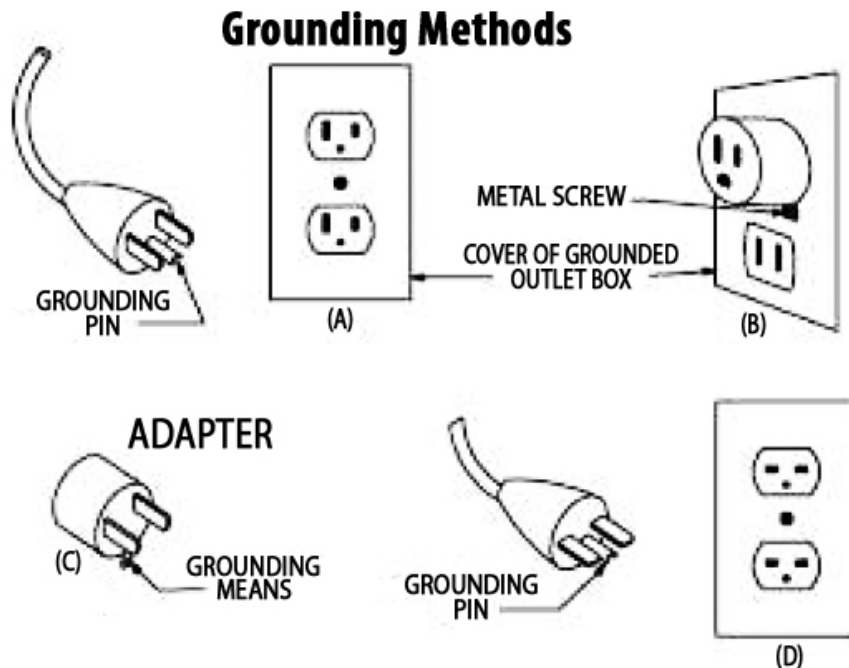

⚠ DANGER:

Before using adapter as illustrated, be certain that center screw of outlet plate is grounded. The green-colored rigid ear or lug extending from adapter must be connected to a properly grounded outlet - make certain it is grounded. If necessary, replace original outlet cover plate screw with a longer screw that will secure adapter ear or lug to outlet cover plate and make ground connection to grounded outlet.

- 2) For model OSC-105A, this battery charger is rated more than 15 amperes and is for use on a circuit having a nominal rating of 120 volts and is factory-equipped with a specific electric cord and plug to permit connection to an acceptable electric circuit. Make sure that the charger is connected to an outlet having the same configuration as the plug. No adapter should be used with this charger.

- 3) For a permanently connected battery charger:

GROUNDING INSTRUCTIONS - This battery charger should be connected to a grounded, metal, permanent wiring system; or an equipment-grounding conductor should be run with circuit conductors and connected to equipment-grounding terminal or lead on battery charger. Connections to battery charger should comply with all local codes and ordinances.

- 4) For a direct plug-in battery charger provided with a grounding pin:

⚠ CAUTION:

Risk of Fire or Electric Shock. Connect battery charger directly to grounding receptacle (three-prong). An adapter should not be used with battery charger.

- 5) For a direct plug-in battery charger having a tab for semi-permanent installation:

Use only with duplex receptacle having center screw;

Secure unit in place by receptacle cover screw;

⚠ CAUTION:

Risk of Electric Shock or Fire. Disconnect power to receptacle before installing or removing unit. When removing receptacle-cover screw, cover may fall across plug pins or receptacle may become displaced.

- 6) For a commercial battery charger that is intended to be permanently installed, this battery charger should be installed so that it is not likely to be contacted by people.

⚠ WARNING: The shipping and packing materials must be removed for proper and safe operation.

Any data, descriptions or specifications set forth herein are subject to change without notice. Before using the product(s), the user is advised and cautioned to make its own determination and assessment of the suitability of the product(s) for the specific use in question and is further advised against relying on the information contained herein as it may relate to any general use or indistinct application. It is the ultimate responsibility of the user to ensure that the product is suited and the information is applicable to the user's specific application. The product(s) featured herein will be used under conditions beyond the manufacturer's control and therefore all warranties, either express or implied, concerning the fitness or suitability of such product(s) for any particular use or in any specific application, are disclaimed. The user expressly assumes all risk and liability, whether based in contract, tort or otherwise, in connection with the use of the information contained herein or the product itself.

TECHNICAL INFORMATION

The nameplate located on the outside of the charger should be used to check this application before installation. The nameplate includes the UL Model number, part number and the ratings of the cabinet at its full capacity.

UL Model Number and Part Number

The UL Model Number specifies the characteristics of this charger, while the Part Number is equivalent in characteristics to the UL Model Number and given by the manufacturer. The Part number and UL Model number are required in any discussion or correspondence regarding this charger.

UL Model Number:

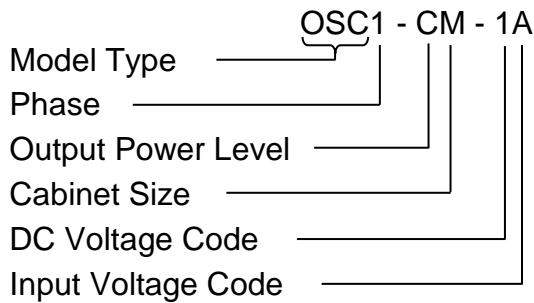

Part Number:

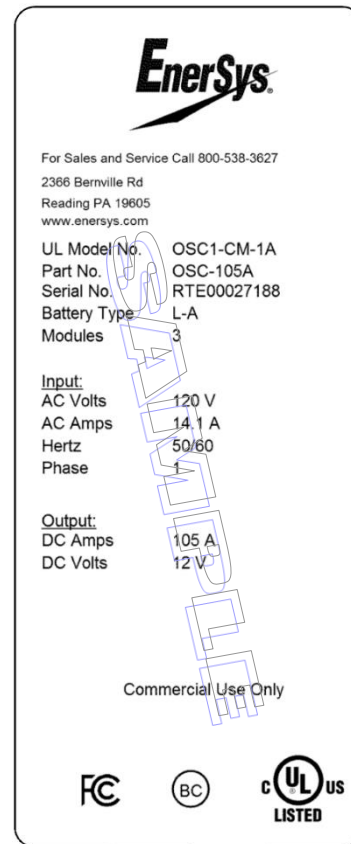
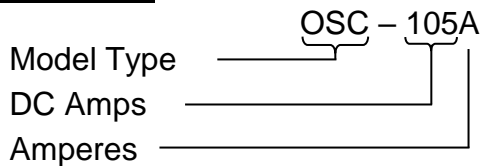

Output Power Level Codes

The following table describes the letter codes to be used in charger Model number to indicate the Output Power of the charger.

Letter Code	Charger Output Power (W)	Number of Modules	Module Power (W)
B	1000	2	500
C	1500	3	500

Cabinet Size Letter Code

The following table describes the letter code to be used in charger Model number to indicate the number of slots and size of the DC cables.

Letter Code	Module Capacity	DC Cable Size	Comments
M	3	4 AWG	Three slot, 1 kW module cabinet

DC Voltage Number Code

The following table describes the number code to be used in charger Model number to indicate the DC output voltage of the charger.

Number Code	Output Voltage
1	12

Input Voltage Letter Code

The following table describes the letter code to be used in charger Model number to indicate the AC line voltage and AC line frequency at which the charger can be operated.

Letter Code	Voltage (Volts RMS)	Line Frequency (Hertz)	Comment
A	120	50/60	120 VAC only

Serial Number

This is the serial number that contains complete information about the charger. It must be supplied with the part/model number on any correspondence or discussion regarding this charger.

Battery Type

The chemical content construction of the battery this unit is designed to charge is given in this part of the nameplate. (L-A = Lead Acid)

Modules

This is the number of modules installed in this cabinet.

AC Volts

This is the nominal voltage this charger is rated for. The charger will only operate on this voltage.

AC Amps

This is the AC Amps current rating of this charger.

Hertz

This gives the frequency in cycles per second of the AC input voltage. Under no conditions operate the charger at a different frequency or from a generator with unstable frequency.

Phase

Number “1” indicates a Single Phase Charger.

DC Amps

This is the DC current that this charger will deliver to a discharged battery with the number of power modules installed.

DC Volts

This gives the nominal DC output voltage of the charger.

CEC

This logo is applied to chargers that are certified with the California Energy Commission in compliance with Appliance Efficiency Regulations:



cULus

This logo is applied to chargers that have been tested to applicable standards and requirements by Underwriters Laboratories (UL) and the Canadian Standards Association (CSA):



FCC

This logo is applied to chargers that have wireless communication and comply with the Federal Communications Commission (FCC):



INTRODUCTION

The ODYSSEY® chargers are compatible with 12V batteries. Battery recognition (voltage, capacity and state of charge) is accomplished automatically by the microprocessor. Furthermore, equalization and refresh charges are integrated.

ODYSSEY chargers are microprocessor-controlled. The processor is programmable to adapt to the battery capacity so that the charging profile can accurately adjust for the battery size. The charging coefficient is maintained at various discharge levels.

AC Power Fail

If the AC power fails with a battery connected to the charger during a charge cycle, the charger will reset and start a new charge cycle when power is restored. All charger settings as well as the time and date are preserved.

Series Charging

In series charging, the voltages of both batteries add up and must match charger's nameplate DC Volts rating. The charger's ampere-hour rating must be equal to each of the battery's ampere-hour rating. Charge cycle will not start unless both batteries are connected.

Charging Profile

The charging profile defines the rate of current charge over time. The charger adapts to the battery's age and level of discharge. Controlling the overcharge coefficient, whatever the battery's discharge level, reduces the amount of electricity consumed.

ODY Profile

This is a charging profile that allows the configuration of the charger for use with ODYSSEY batteries and flooded automotive batteries. The profile is an IE (constant current, constant voltage) type with a number of user configurable parameters.

Equalization Charging

Equalization charging, performed after normal charging, balances the electrolyte densities in the battery's cells.

Refresh Charging

Refresh or maintenance charging enables the battery to be maintained at maximum charge all the time while connected to the charger.

FEATURES

Control Panel

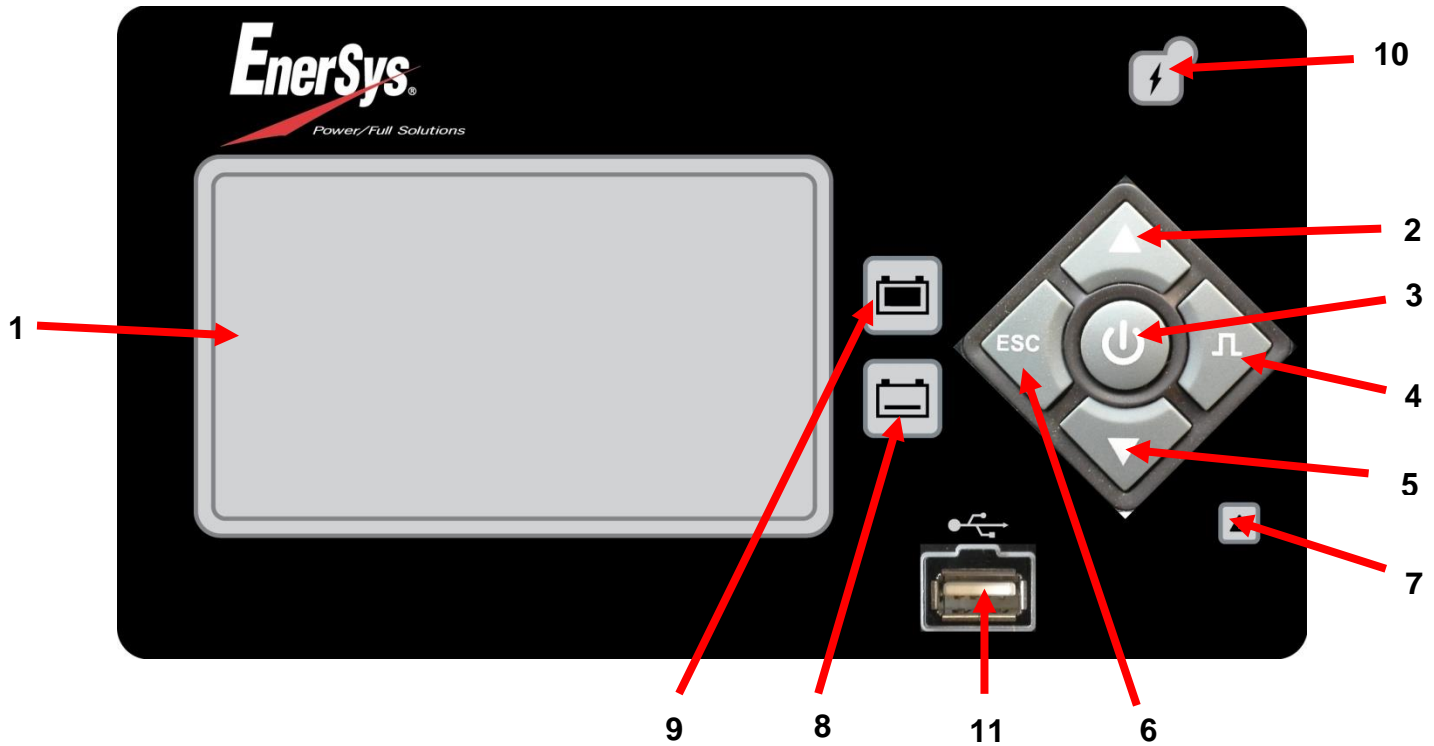

Ref	Function	Description
1	Graphical TFT display	Display charger operation info/Menus
2	Navigate UP button	Navigate menus/Change values
3	ENTER/STOP and START button	Select menu items/Enter values/Stop and restart battery charge
4	Navigate RIGHT/EQUALIZE button	Scroll right/Start equalize or desulfation
5	Navigation DOWN button	Navigate menus/Change values
6	Navigation LEFT/ESC button	Enter Main Menu/Scroll left/Exit menus
7	RED fault indicator	OFF = no fault, ON = fault FLASHING = ongoing fault detected
8	YELLOW charging indicator	OFF = charger output is off ON = charging in progress
9	GREEN charge complete indicator	OFF = charger off or battery not available Flashing = cooling phase ON = battery ready and available
10	BLUE AC supply indicator	OFF = AC missing, ON = AC present
11	USB port	Download memos/Upload software

INSTALLATION

▲ WARNING: The shipping packaging and materials must be removed for proper and safe operation

Charger Location

- Locate charger as far away from battery as DC cables permit.
- Never place charger directly above battery being charged; gases from battery will corrode and damage charger.
- Never allow battery acid to drip on charger when reading electrolyte specific gravity or filling battery.
- Do not operate charger in a closed-in area or restrict ventilation in any way.
- Do not set a battery on top of charger.
- For maximum safe operation, choose a location which is free of excess moisture, dust, combustible material and corrosive fumes. Also, avoid locations where temperatures are high or where liquids will drip on the charger. Do not mount charger on or over a combustible surface. The recommended charger mounting location should provide a radial distance of at least 28 inches away from the closest top edge of the battery.

Shelf Mounting

- The charger may be mounted on a wall, stand, shelf, cart or floor in a vertical position. The minimum distance between two chargers must be 12 inches.
- The charger may be installed with the brackets supplied. See the Mounting Dimensions section at the end of this manual for proper bolt pattern.

DC Plug Polarity

The charger's battery cables/clamps are connected to the DC output of the charger and are color-coded. Red is positive; black is negative.

NOTE: Ambient temperature at all levels cannot exceed 113°F (45°C).

ASSEMBLY INSTRUCTIONS

If charger is provided with a DC Clamps cord assembly, connect the DC connector side of the cord assembly to the DC connector of the charger. Make sure the connector's polarity and cable colors match before making the connection. **Never allow clamps to touch each other.**

PREPARING THE CHARGER

Connecting AC Power

⚠ CAUTION: Read Important Safety Instructions section related to AC Power Cord.

Plug the charger AC grounded power cord into a 120-volt AC outlet with appropriate voltage and amperage rating. With the charger in idle mode (no battery connected) and without pressing any button, the display will show the following information:

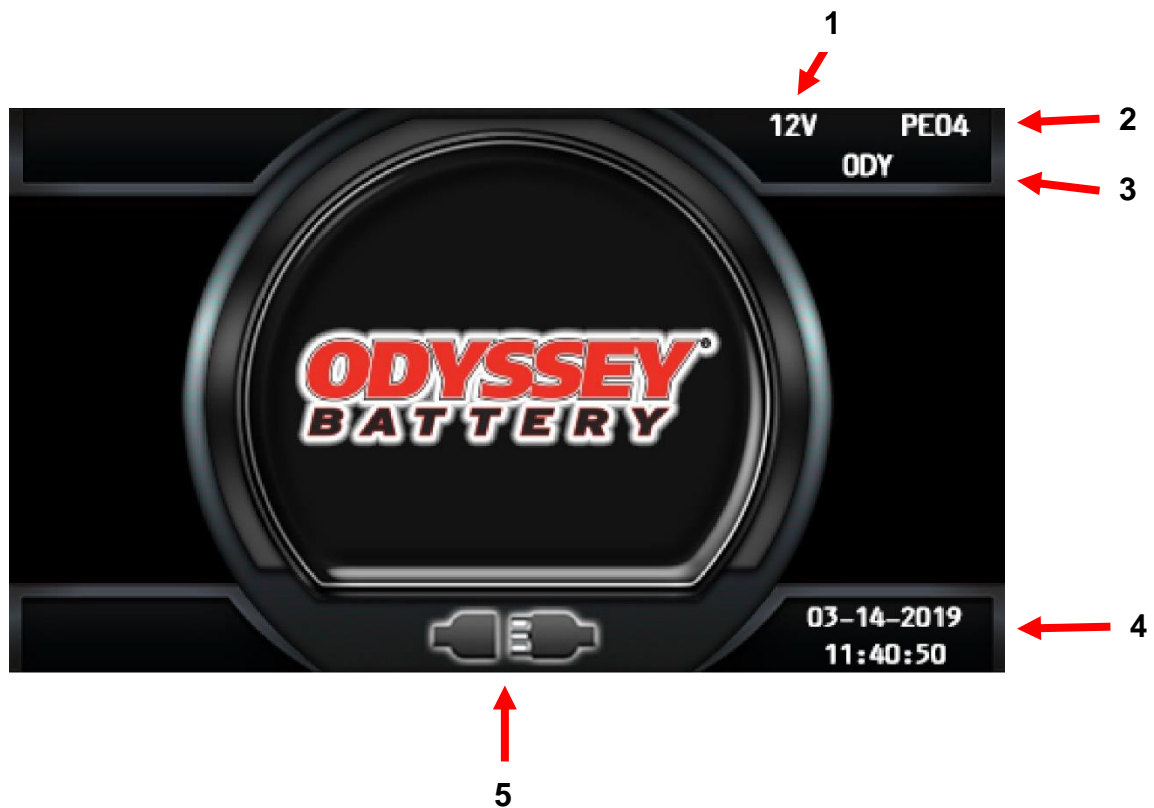

Ref	Description
1	Charger DC Voltage
2	Firmware Version
3	Selected Charge Profile
4	System Time and Date
5	Connect Battery

Main Menu

When the charger is idle mode, press and hold <ESC>, the Main Menu shown below is displayed. The main menu is automatically exited after 60 seconds of inactivity or can be exited voluntarily by pressing the <ESC> button.

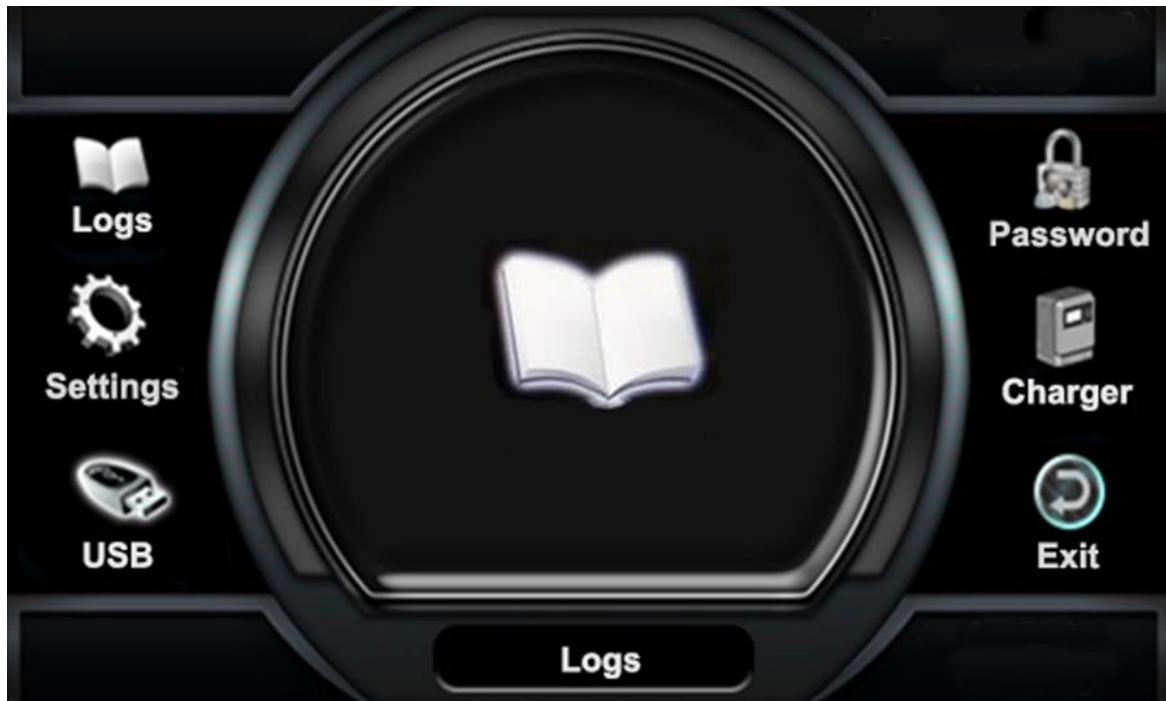

All menus are accessed from Main Menu page; a detailed description of each menu is explained in the next sections of this manual. The menus that require a password are not displayed until the correct password has been entered.

The menus provide access to the following functions:

- View status and memorizations (**LOGS** icon).
- Viewing of faults, alarms, etc. (**CHARGER** icon).
- USB functions (**USB** icon).
- Setting of date, language and others (**SETTINGS** icon).
- Management of password (**PASSWORD** icon).
- Exit main menu (**EXIT** icon).

LOGS

Memorizations Display Screen

The charger can display the details of the last 300 charge cycles. The display below shows 3 charges have been stored in memory. MEMO 1 is the latest charge memorized. After memorizing the three-hundredth charge, the oldest record is deleted and replaced by the next oldest.

Logs	
Memo	1 04/21/14 21h 10
Memo	2 04/20/14 19h 15
	3 04/19/14 15h 25

Displaying a Charge Cycle

Proceed as follows:

1. Select a record (MEMO x) using the ▲/▼ buttons.
2. Display the first History screen by pressing Enter.
3. Display the second History screen by pressing ▼.
4. Return to the Main Menu by pressing Esc.

The charge history is displayed; use the ▲/▼ to scroll through the parameters.

Memorization Data

Memo	Description
Capacity	Rated battery capacity (AH)
U batt	Rated battery voltage (V)
Temp	Battery temperature at start of charge (F)
Techno	Battery technology
Profile	Selected profile
% init	State of charge at start of charge (%)
U start	Battery voltage at start of charge (Vpc)
U end	Battery voltage at end of charge (Vpc)

Memo	Description
Temp end	Battery temperature at end of charge (F)
Chg Time	Time of the charge cycle (minutes)
AH	Amp-hours returned during charge cycle
kWh	Kilowatt-hours returned during charge cycle
Status	Partial or Complete
Default	Fault codes
SoC	Start of charge date and time
DBa	Battery disconnect date and time

STATUS

This menu displays the status of the charger’s internal counters (number of normal and partial charges, fault code, etc.).

Status Screen



Status	Description
Charge	Total number of charges - corresponds to the total of normally terminated charges and charges terminated with or by faults
Complete	Number of charges normally terminated
Partial	Number of charges abnormally terminated
TH	Number of charger temperature faults
DF1 etc.	Number of faults recorded by the charger (see Fault Codes)

CHARGER

This menu displays information on the chargers configuration and output current of the charger and the power modules.

Information

This screen displays the following information on the charger’s configuration.

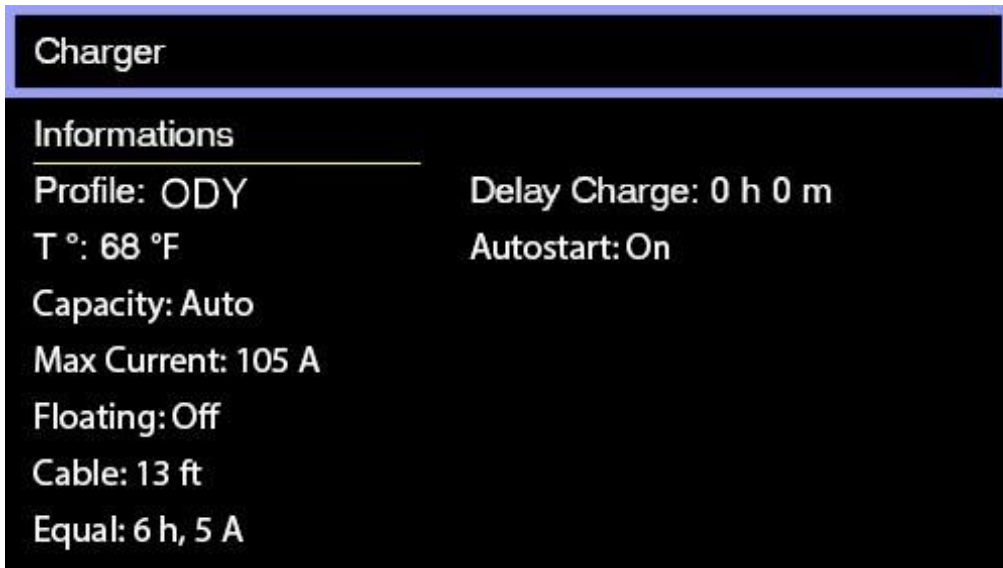

Information	Description
Profile	Selected Charging Profile
Temperature	Programmed temperature
Capacity	Automatic or Manual
Max. Current	Maximum Current of Charger
Floating	ON/OFF
Cable	Length of DC Cable
Equal	Equalize Time and Current
Delay Charge	In Hours and Minutes
Auto Start	ON/OFF

USB

This menu provides access to the USB function to update software.

Update Software

Updates charger's internal software. The software is provided by EnerSys®.

SETTINGS

Parameters

Date/Time

Sets date and time of the charger. The clock has a battery backup which will preserve the time when power to the charger is off.

Language

Selects the language displayed in the menus.

Region

Selects the format for date, metric (EU) or imperial (US) units for temperature, length and cable gauge.

Display

Set screen saver function and display Themes.

Screen Saver







Enables or Disables the screen saver function.

Delay

Set the time the screen stays illuminated. The delay time is adjustable in minutes up to one hour and 59 minutes.

Themes

Themes A and B are two different ways that information is displayed throughout the charge cycle as seen in table below. Theme A is selected by default and will be used in this manual.

FUNCTION	Theme A	Theme B
<p>IDLE Screen</p>		
	<p>Battery Disconnects while Charging. Alternates every two seconds with CONNECT BATTERY.</p>	
	<p>Charger paused while battery connected</p>	
<p>CHARGING Screen</p>		

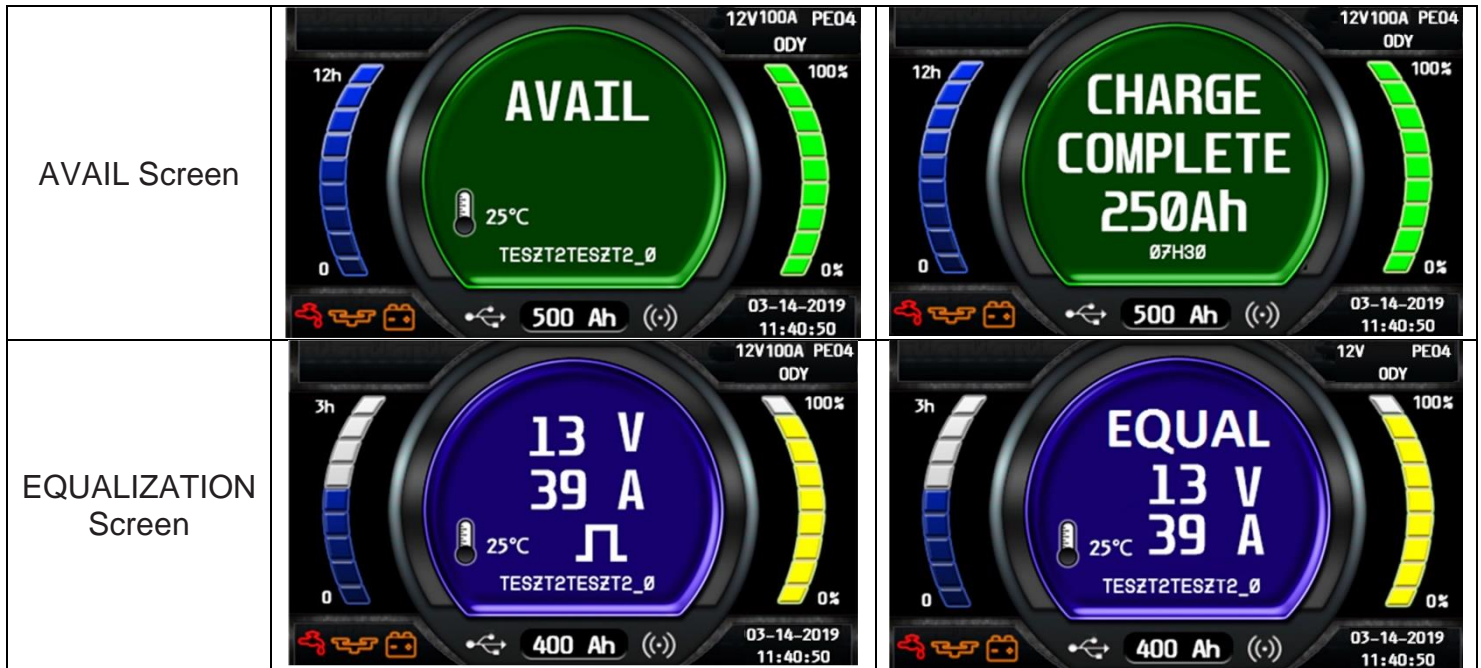

Daylight Saving

Enables or disables automatic clock adjustment for daylight savings time. When enabled, time will move ahead one hour at 02:00 on the second Sunday in March and will move back one hour at 02:00 on the first Sunday of November. The charger must be powered up at the time of the change for it to take effect.

PASSWORD

This is where the password is entered to gain access to service level menus by authorized EnerSys® service personnel.

STARTING THE CHARGE CYCLE

READ ALL CAUTIONS AND WARNINGS POSTED ON CHARGER AND IN THIS MANUAL. The charger's battery clamps are color-coded. Red is positive and black is negative.

Connecting to the Battery

Connect the battery clamps correctly to battery posts following the steps outlined in the "IMPORTANT SAFETY INSTRUCTIONS" section of this manual. The output polarity of the charger must be observed when connecting to the battery. Improper connection will open/clear the DC fuse. **Never allow clamps to touch each other.**

Delayed Start

If the charger was programmed for delayed start, charging will begin following that delay. When the battery is plugged in to the charger, the display shows the time remaining before the programmed charging starts.

Count Down Display



Charging starts after the programmed delay. The charger uses Profile, Capacity and Temperature settings programmed in the Configuration menu.

Charger Display

A few moments into the effective charge, the display will begin alternating between the following charging information:

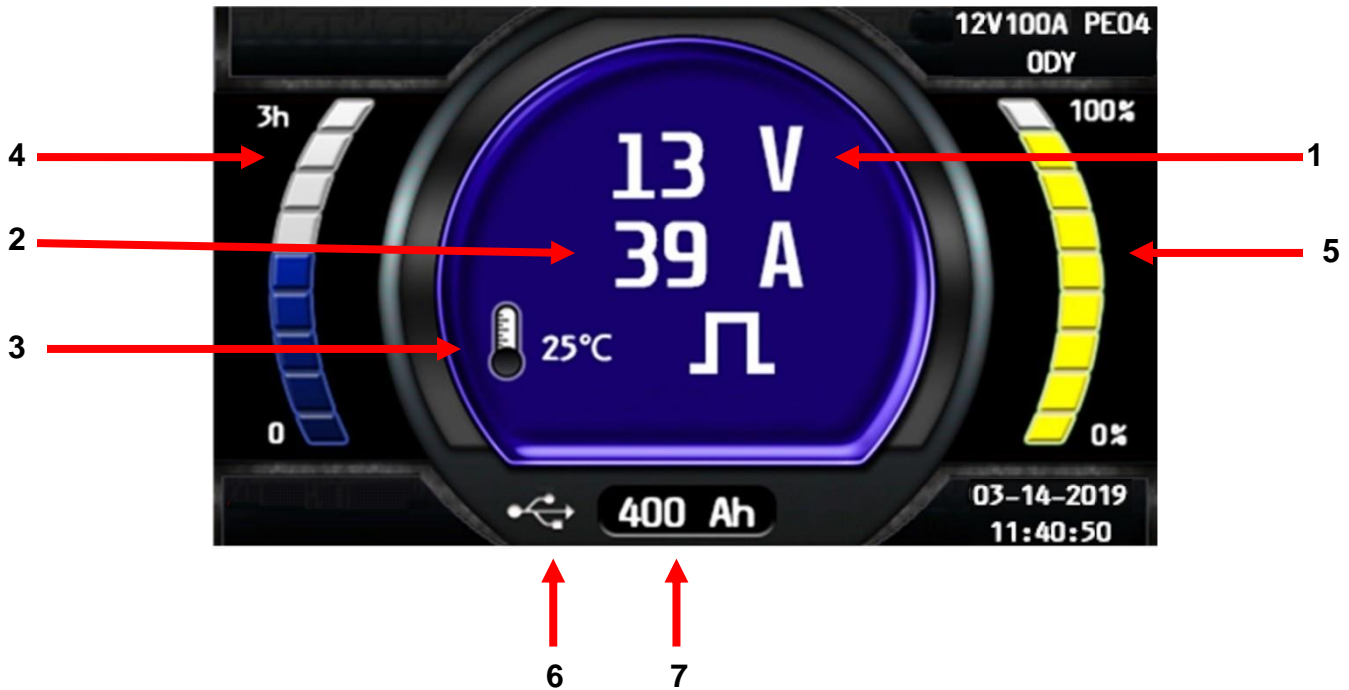

Ref	Description
1	Charge Voltage (total V and V/c)
2	Charge Current
3	Battery Temperature, Alternates with AH Returned
4	Charge Time
5	Percent of Charge
6	USB Connection
7	Battery Capacity

Charge current is determined by the battery voltage and its state of charge condition. Charge current declines automatically as battery voltage rises during the charge. As the battery charges, the LCD display will output various charge parameters including the percentage of battery capacity.

End of Charge Display



End of Charge

The green complete LED comes on after proper end of charge. The green complete LED is on and the display shows AVAIL. The display alternates between:

- Total charging time.
- Amp-Hours restored to the battery.

Any other lit LED indicates a problem during charging. Please refer to paragraph *Control Panel* for more information.

If the battery remains plugged in and refresh charge has been enabled, refreshes will occur to maintain an optimal charge.

The battery is now ready for use. Push the STOP button and disconnect AC plug before disconnecting the battery. When disconnecting, disconnect chassis lead first.

Disconnecting the Battery

Always disconnect AC cord first. Remove clamp from vehicle chassis if battery inside vehicle, or from negative battery terminal while keeping as far away from battery as possible if battery outside vehicle, and then remove clamp from battery post.

FAULT CODES

Fault Display



In case of a fault, one of the corresponding fault codes listed below will appear on the display. If it is a critical fault, charging will stop and the red Fault LED will be illuminated.

Fault	Critical	Cause	Solution
DF1	Yes	Low output current	Check input voltage and fuses.
DF2	Yes	Output fault	Check for proper battery connection (reversed polarity). Check output fuse.
DF3	Yes	Incorrect battery	Battery voltage too high (>2.4 Vpc) or too low (<1.6 Vpc). Use proper charger for battery.
DF4	No	The battery has been discharged more than 80% of its capacity.	Prevent future over discharging of battery. Battery charge gauges may need calibration.
DF5	No	Battery requires inspection	Non critical fault. Check battery cables for condition and size, check for loose connections or defective cells.
DF7	No	Inspect battery	Non critical fault. This will cause the charge to terminate early. Battery may require service. Check the battery temperature. Check the battery condition of use. Check the configuration in the menu (charge cables parameters).

Fault	Critical	Cause	Solution
TH or TH-Amb	Yes	Charger overheating	Check that fans are working. Verify that ambient temperature is not too high. Inspect to see if charger ventilation is obstructed or impaired.
BAT TEMP	Yes	Battery temperature reached maximum level.	Allow battery to cool down.
MOD TH	No	Alternating with charge parameters – one or more module in thermal fault – the charge process continues – the fault module(s) is(are) displayed + red led flashing.	Check that the fan(s) is (are) working correctly and/or that the ambient temperature is not too high or whether there is poor natural ventilation to the charger. If all modules are in thermal fault a TH fault will follow.
DFMOD	No	Alternating with charge parameters – one or more module in DF1 fault – the charge process continues – the fault module(s) is (are) displayed + red led flashing.	Check power modules. If all modules in DF1 fault a DF1 error will follow.
DEF ID	Yes	Blocking fault – one or more modules are not compatible with the charger configuration. This can happen if the user replaces one module with another one with a different voltage setting.	Use correct module(s).
	No	Battery balance fault	Check battery cell voltages.

MAINTENANCE INSTRUCTIONS

⚠WARNING: THERE ARE DANGEROUS VOLTAGES WITHIN THE BATTERY CHARGER CABINET. ONLY A QUALIFIED PERSON SHOULD ATTEMPT TO ADJUST OR SERVICE THIS BATTERY CHARGER.

The charger requires minimal maintenance. Connections and terminals should be kept clean and tight. Care should be taken during cleaning. Make sure that both the AC lines and the battery are disconnected before cleaning. The frequency of this type of maintenance depends on the environment in which this unit is installed.

For service, contact your sales representative or call:

**1-800-ENERSYS (USA)
1-800-363-7797**

MOVING AND STORAGE INSTRUCTIONS

- Do not expose the charger to moisture. Store in dry location.
- Carefully move the charger when needed. Do not operate the charger if it has been dropped, received a sharp hit or otherwise damaged in any way.

CABINET MOUNTING DIMENSIONS

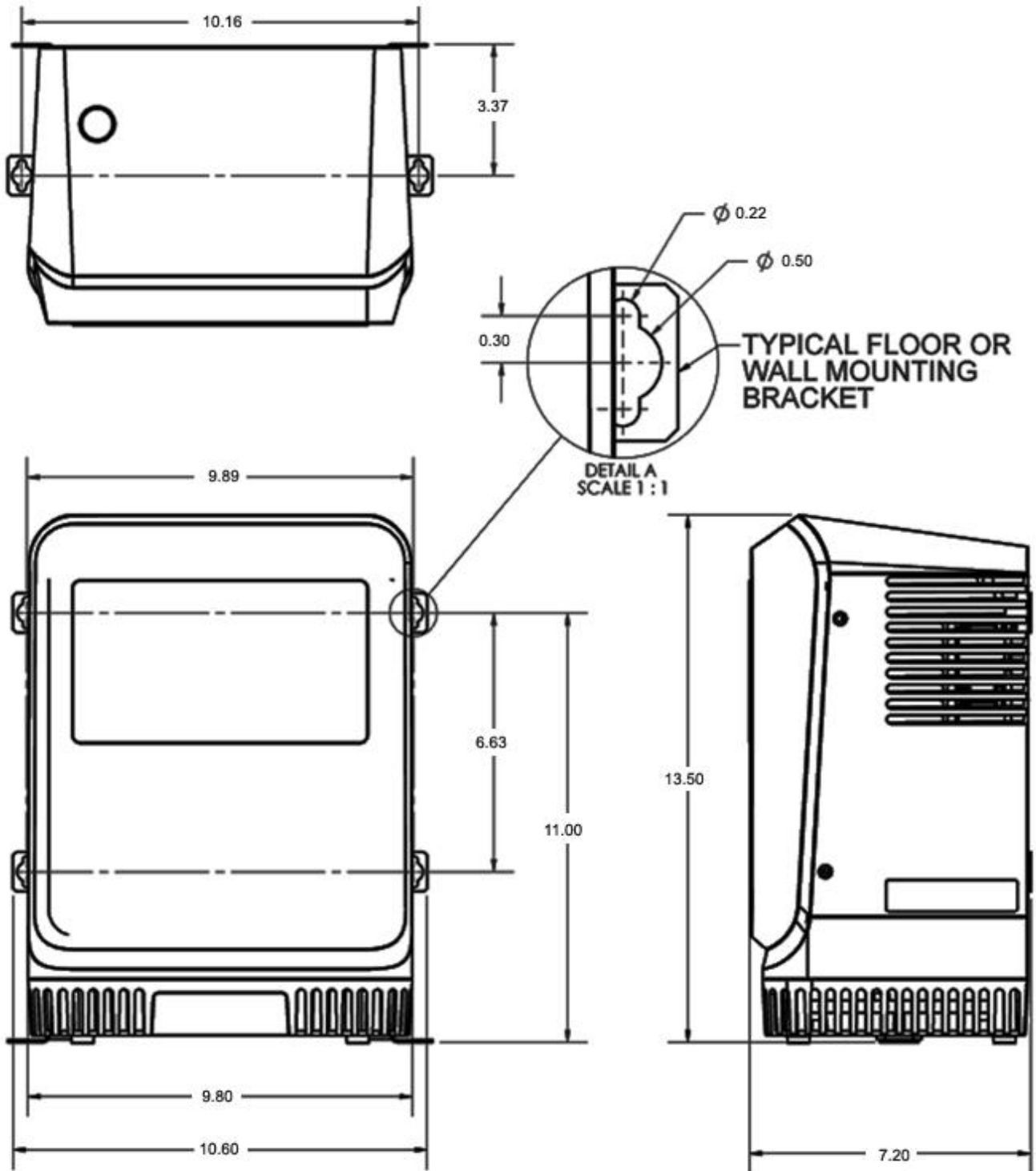

Dimensions shown are in inches.

TECHNICAL SPECIFICATIONS

Part Number (UL Model)	AC Input					DC Output			Charger Cable AWG
	Voltage	Max Amps	Phase	Min Cord AWG	NEMA Plug	Cells	kW	Max Current (A)	
OSC-70A (OSC1-BM-1A)	120	9.4	1	16	5-15	6	1	70	4 AWG
OSC-105A (OSC1-CM-1A)	120	14.1	1	14	5-20	6	1.5	105	4 AWG

FUSE REPLACEMENT

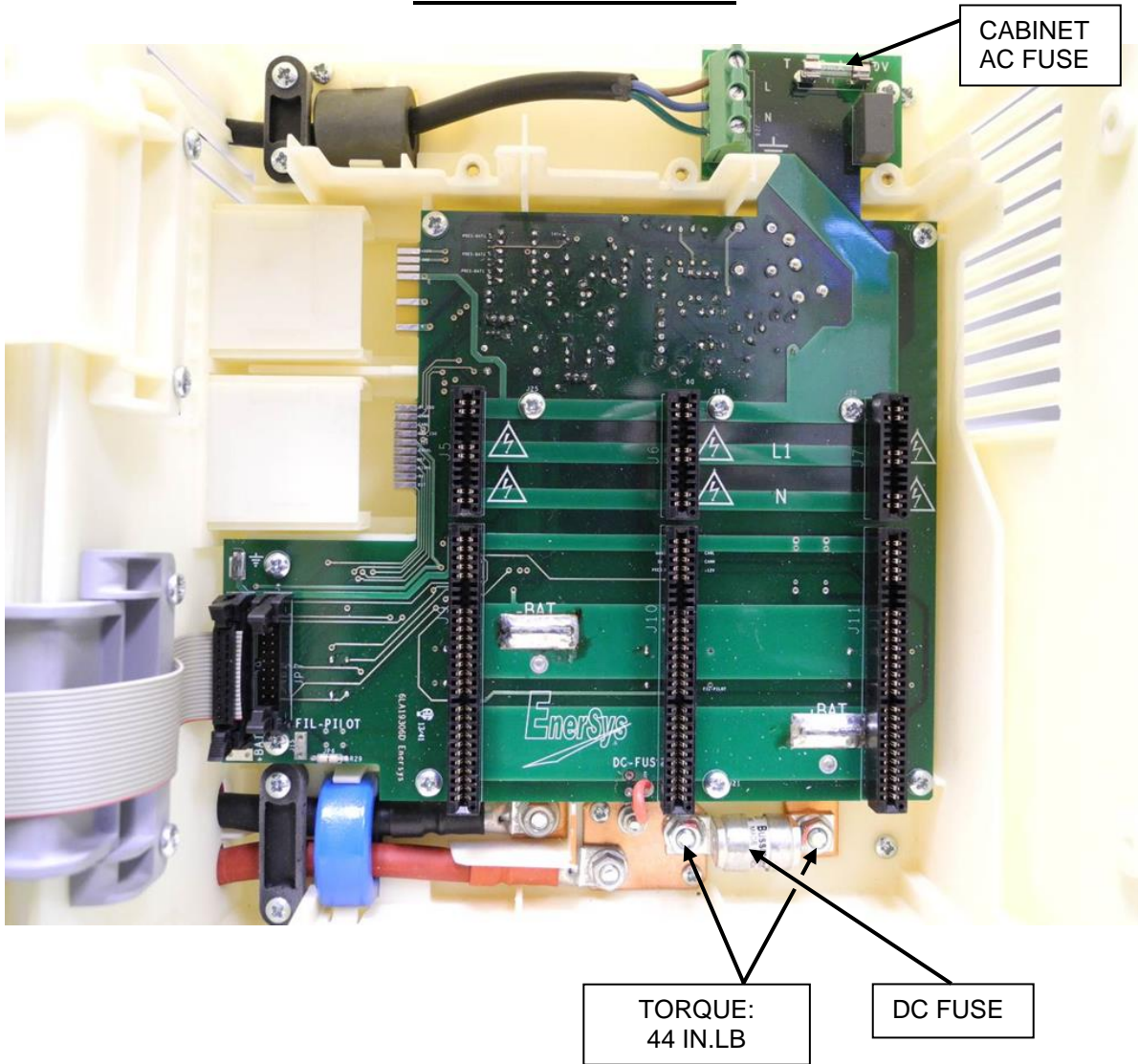

FUSE	Voltage (Volts)	Amps (A)	Description
AC	250 VAC	1	SCHURTER AG, 5x20,1A, 250Vac, UL recognized (JDYX2)
DC	125 VDC	125	Bussmann 160LET, 125A, 125Vdc

MAINTENANCE LOG

1. Modifications to Factory Settings

Date	Variable	Change	Service Technician

2. Service

Date	Description	Service Technician



EnerSys World Headquarters
2366 Bernville Road
Reading, PA 19605, USA
Tel: +1-610-208-1991 /
+1-800-538-3627

EnerSys EMEA
EH Europe GmbH
Baarerstrasse 18
6300 Zug, Switzerland

EnerSys Asia
152 Beach Road
#11-08 Gateway East Building
Singapore 189721
Tel: +65 6416 4800

Want more info?
Scan code to access
The ODYSSEY® Battery
Literature Library



AM-OSC3BAY-IM Rev AA August 2019

© 2019 EnerSys. All rights reserved. Trademarks and logos are the property of EnerSys and its affiliates, except for the BC, FCC and UL logos which are not the property of EnerSys.

Subject to revisions without prior notice. E.&O.E.